



Building Construction Field Systems
Trimble Buildings

FieldLink
User Guide
v6.4

Westminster Office

Trimble, Inc.
10368 Westmoor Drive
Westminster, Colorado 80021
(720) 887-6100

Copyright and Trademarks

© 2022, Trimble, Inc. All rights reserved. All other trademarks are the property of their respective owners.

Release Notice

The topics within this manual are subject to change without written notice. Companies, names, and data used in any examples are fictitious. Screenshots included in the help topics may not be exactly as in the software application.

Revisions:

October 2016 – BW
March 2017 – BW
June 2017 – BW
Sept 2017 – BW
Dec 2017 – AS, BW
June 2018 - IW
October 2018 - IW
December 2018 - IW, BW
February 2019 - IW
July 2019 - IW
December 2019 - KD, IW
February 2020 - KD, IW
June 2020 - KD, MT
September 2020 - KD, MT
December 2020 - KD, MT, AS
March 2021 - KD, AS
June 2021 - AS, KD, DA
October 2021 - AS
December 2021 - AS, KD
July 2022 - KD, BW
September 2022 - BW

Legend

The following symbols are used in this document.



Important

Indicates an important concept, step, or caution.



Tip

A shortcut or timesaving tip.



Note

Additional information or situation users may encounter.

1. FieldLink Installation & Updates	9
1.1 Trimble Installation Manager (TIM)	9
1.2 FieldLink Feature Packs & Modules	9
2. User Interface	10
2.1 Work Mode Icons	10
2.1.1 Create	10
2.1.2 Measure	11
2.1.3 Device	12
2.1.4 More	12
2.1.5 Map	13
2.1.6 Projects	13
2.1.7 Reports	13
2.1.8 Trimble Connect	13
2.1.8.1 Status Sharing	14
2.1.9 About	14
2.1.10 Minimize	14
2.1.11 Exit	14
2.2 Map Controls	14
2.2.1 Zoom Extents and Preset Views	15
2.2.2 Pan/Orbit	15
2.2.3 Slider	15
2.2.4 Point List	15
2.2.5 Information	18
2.2.6 Map Settings	19
2.2.7 Layer	21
2.2.8 Section View	24
2.2.9 Model Management	26
2.2.9.1 Transform, Rotate and Scale a Model to Another Model using 2 Points (Office and Field)	28
2.3 Workslate Area	29
2.4 Map Tools	29
2.5 Compute Tools	30
2.5.1 Compute Distance	30
2.5.2 Compute Angle	31
2.5.3 Compute Area & Volume	32
2.5.4 Down and Out Calculation	33
3. Projects	33
3.1 Creating a New Project	33
3.2 Steps to create a TFLX file	34

3.3	Converting Existing TFL Files from Previous FieldLink Versions	35
3.4	Importing Files	35
3.4.1	Steps to Import a Model or PDF into a Project	35
3.5	Exporting Data	36
3.6	Managing a Project	36
3.6.1	Deleting Job Files	37
3.7	Job Settings	37
4.	Create Mode	38
4.1	Point Manager	38
4.1.1	Input Point	38
4.1.2	Create Point Anywhere	40
4.1.3	Single Point Offset	41
4.1.4	Create Multiple Offset Points - Line	42
4.1.5	Create Multiple Offset Points - Arc	43
4.1.6	Create Point – In Wall	44
4.1.7	Point Manager	45
4.2	Plan	47
4.3	Linework	48
4.4	From Model	50
4.5	Grid	52
4.6	Pattern	53
5.	Device Mode	58
5.1	Connection	58
5.1.1	Robotic Total Stations (RTS)	58
5.1.2	Trimble TDL2.4 Data Link Radio	59
5.1.3	Rapid Positioning System (RPS)	60
5.1.4	Trimble Ri	60
5.1.5	Global Navigation Satellite System (GNSS)	61
5.2	Prism Settings	62
5.2.1	Prism Quick Access	63
5.2.1	Tap to Search	65
5.2.2	Pano-Search	67
5.3	Trimble Ri Vision and Joystick Controls	69
5.4	Device Settings	71
5.5	Measure Reference Elevation	71
5.6	Turn To (Theodolite type option)	72
5.7	Tools	72
5.7.1	Quick Vertical Alignment Check Tool	73
5.7.2	Tape Measure Tool	75
5.8	Set Up	76
5.8.1	Set Up - No Data	76
5.8.2	Set Up - Unknown Location (Resection)	77
5.8.3	Set Up - Known Point	81

5.8.4 Set Up - Panorama	82
5.8.5 Set Up - Use Rounds (Optional Module)	83
5.8.6 Set Up - Grid Lines	83
5.8.7 Component Based Set Up	85
5.8.8 GNSS Set Up - Unknown Location	89
5.8.9 GNSS Set Up - Known Location	90
5.8.10 GNSS Set Up - No Data - Can be performed in a job with no imported points or model data.	92
5. Traverse	92
5.9.1 Traverse (Optional Module)	93
6. Measure Mode	98
6.1 Settings	98
6.2 Collect	99
6.2.1 Collect Points	100
6.2.2 Collect Line	100
6.2.3 Collect Arc	101
6.2.4 Collect Circle	101
6.2.5 Collect Points Using Rounds (Optional Module)	103
6.3 Layout	103
6.3.1 Layout Points	103
6.3.2 Point Layout List	106
6.3.3 Point Transfer	107
6.3.4 Layout Line	107
6.3.5 Layout to a Line	109
6.3.6 Layout Arc	109
6.3.7 3D Perspective Model View	111
6.3.8 Create Points - Layout Line	112
6.4 Wall Penetration	113
6.5 Surface (Optional Module)	114
6.5.1 Define and Measure the Surface Area	114
6.5.2 Calculate High & Low Areas	115
6.5.3 Layout a Contour	116
6.6 Layout Plane	116
6.6.1 Flat Plane	117
6.6.2 Tilted Plane	118
6.6.3 Sloping Plane	118
7. Reports Mode	119
7.1 Layout Deviation Report	119
7.2 Daily Layout Summary	122
7.3 Field Report	122
7.4 Surface Report	123
8. Project Management Module - Status Sharing	126

8.1 Status Sharing for Trimble Connect or Tekla Structures	126
8.2 Status Sharing for FieldLink	127
9. Scanning Module	128
9.1 Connect to the X7 Scan Device	129
9.2 Establish X7 Device Location	130
9.2.1 Plan North Set Up	130
9.2.2 No Data Set Up	131
9.2.3 Background Plan or Model Set Up	132
9.2.4 Component Based Set Up	133
9.3 X7 Scan Settings	134
9.3.1 Scan Settings	134
9.3.1.1 Fast Capture Mode	135
9.3.2 Camera Settings	135
9.4 Viewing Scans in FieldLink	136
9.4.1 Viewing Options Ribbon	137
9.4.2 Scan Data Colors	137
9.4.2.1 Changing Scan Elevation Settings	138
9.4.3 Point Size	138
9.4.4 Station Markers	139
9.4.5 Point Cloud View Options	139
9.4.6 Plan View	140
9.4.7 Station View	140
9.4.7.1 Using Station View to Control Laser Pointer	141
9.4.7.2 Tap and Search for Targets in Station View	141
9.4.8 Perspective View	142
9.4.8.1 Viewing Panorama Images	142
9.4.9 Station Manager	143
9.4.9.1 Colorizing a Scan	143
9.4.9.2 Creating Panorama	144
9.4.9.3 Assigning Scans to Layers	146
9.4.10 Extract Detail/Density from Region Within Scans	148
9.4.11 Create TFL Points from Scanned Data	148
9.5 Measuring/Calculations	149
9.5.1 Screen Capture/Screenshot	149
9.6 Annotations and Markers	151
9.6.1 Adding an Annotation	151
9.6.2 Adding a Marker	152
9.7 Floor Analysis	153
9.7.1 Floor Flatness and Floor Levelness	154
9.7.2 Contour and Point Creation	157
9.7.3 Contour and Point Layout	161
9.8 Inspection	161
9.9 X7 Scan Registration	164

9.10 X7 Refining Scans	165
9.11 X7 Scan Export and Diagnostics Report	166
9.11.1 Export	166
9.11. 2 Diagnostics Report	167
9.11.3 Calibration Report	168
9.11.4 Log Files	168
10. GNSS Module	169
10.1 GNSS Set Up	170
10.2 Tilt Calibration	170
10.3 Layout	171
11. Robotics Module - Spot Integration	174

1. FieldLink Installation & Updates

1.1 Trimble Installation Manager (TIM)

Trimble Installation Manager allows the user to install and/or update FieldLink, and other software for your tablet, computer or hardware.

1. If TIM is not installed on your FieldLink Tablet, make sure you are connected to the internet and go to **www.trimble.com/installationmanager/**.
2. Tap "**Download Trimble Installation Manager (Online)**" and follow the instructions on the web page.
3. If **TIM** is already installed but you cannot find the program icon, type "Trimble Installation Manager" in the search bar in the lower left corner of Windows.
4. Tap **TrimbleInstallationManager.msi** once it is fully downloaded to install.
5. Trimble Installation Manager will open and show all products currently purchased by the customer for that device (Computer, Controller, Receiver).
6. Once Trimble Installation Manager loads with the latest information available for versions and updates, the **Version** button will be available in the upper right.
7. Tap the **Version** button to load previous versions of FieldLink, or check to make sure the latest update has been selected. TIM will automatically default to the latest version of FieldLink but you can change to an earlier version if needed.
8. If you do not see the software, firmware or modules you have purchased, tap the  **About** button (About), copy the entire **Computer unique ID** for your device and send this ID to your Trimble representative.
9. Once you have all the software, firmware and modules needed on the screen, tap the **Install** button and follow all prompts.
10. Utilize the **Help** button to access additional information and instructions.

1.2 FieldLink Feature Packs & Modules

FieldLink offers Feature Packs including Core and Advanced, as well as individual Modules. The Feature Packs and Modules allow you the flexibility to implement only the functionality that you need and to scale incrementally as your business needs grow as well as your knowledge of the program. The user interface will vary slightly based upon which Feature Pack and/or Modules you have purchased. Please contact your local Sales Representative for the latest Matrix.

2. User Interface



2.1 Work Mode Icons

The Work Mode icons will be available at all times while FieldLink is open. Any of the Work Modes icons can be tapped at any point in time to access the various operations.

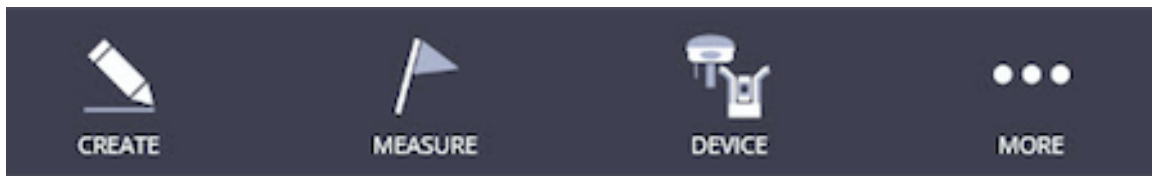

The **FieldLink** home screen will open with the **Work Mode** icons across the top of the screen. The **Work Modes** are a logical division of work features within the program.

2.1.1 Create



Create is where users can create, modify or delete project data including a plan view of a project, linework, points, points from a model, grid points or point patterns.

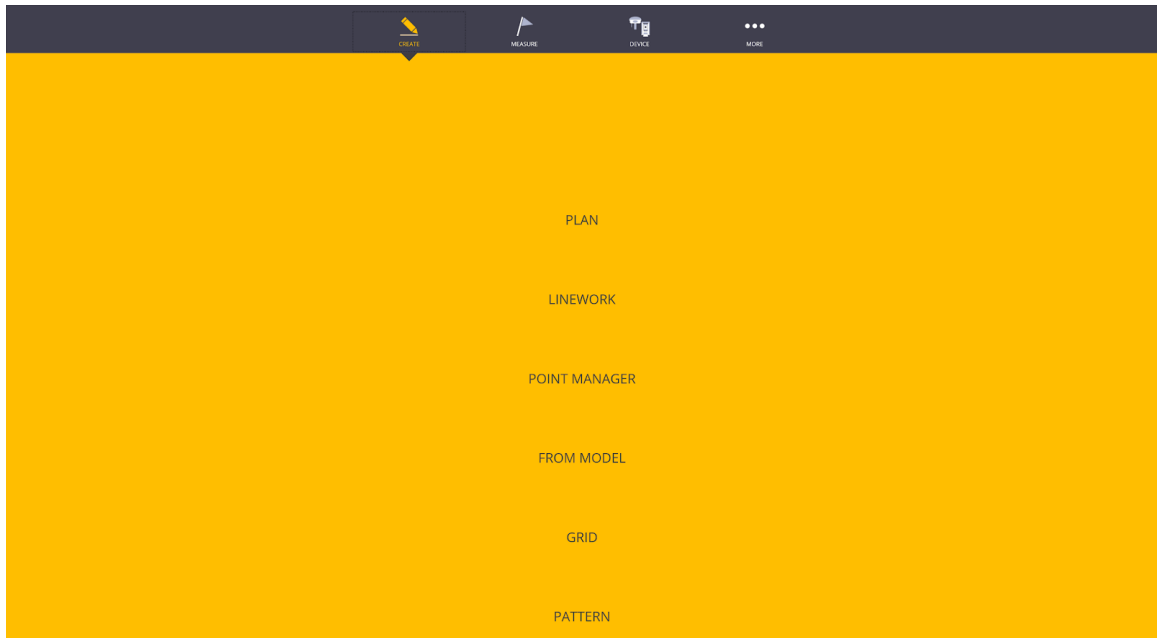

2.1.2 Measure



Measure is where users Lay Out Points, Lines, Offsets, Arcs; Collect Points, Lines, Arcs; Auto Collect Square Cateye Control Points, Layout Wall Penetrations, Layout Planes, Collect and Layout Surfaces, and change measurement Settings such as Tolerances, Next or Nearest Points, Visual Layout or Standard Laser mode, and High Precision or Fast Precision.

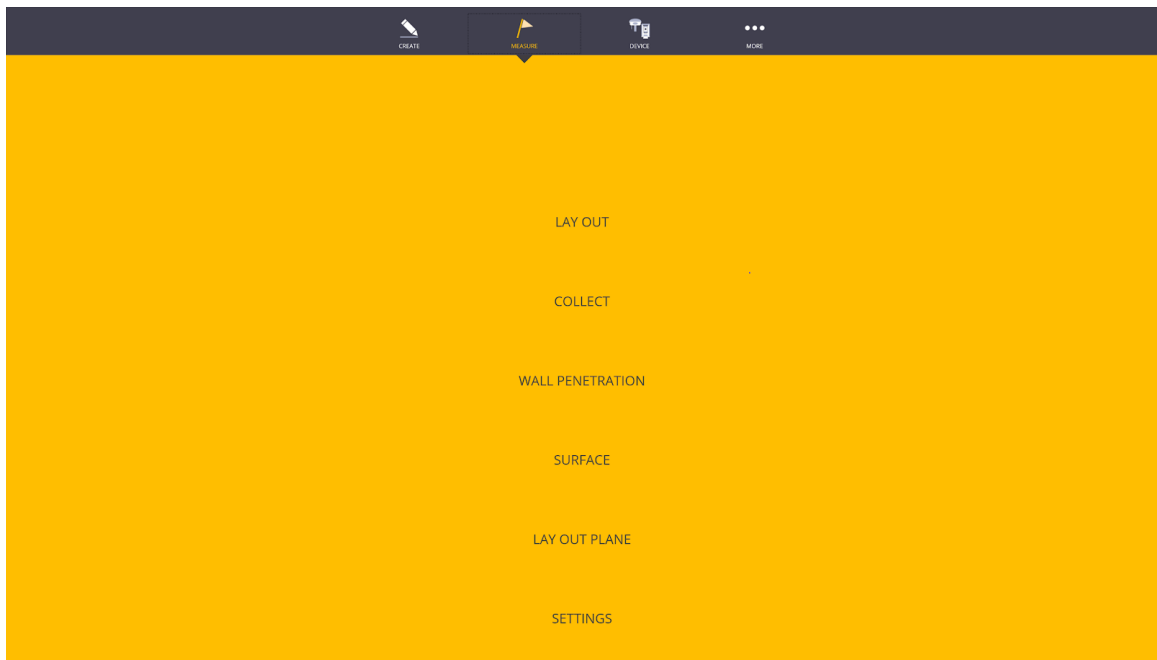



2.1.3 Device

Device is where users connect to the RTS, RPT, GNSS or 3D Laser Scanner, set up the instrument location, and change instrument and target settings. If you have purchased GNSS equipment, you will have the option to connect to the Trimble R8s GNSS receivers and VRS networks. If you have a Trimble Tablet with a built-in radio or optional external radio, you will have the ability to connect to various Trimble Robotic Total Stations and the X7 3D Laser Scanner.

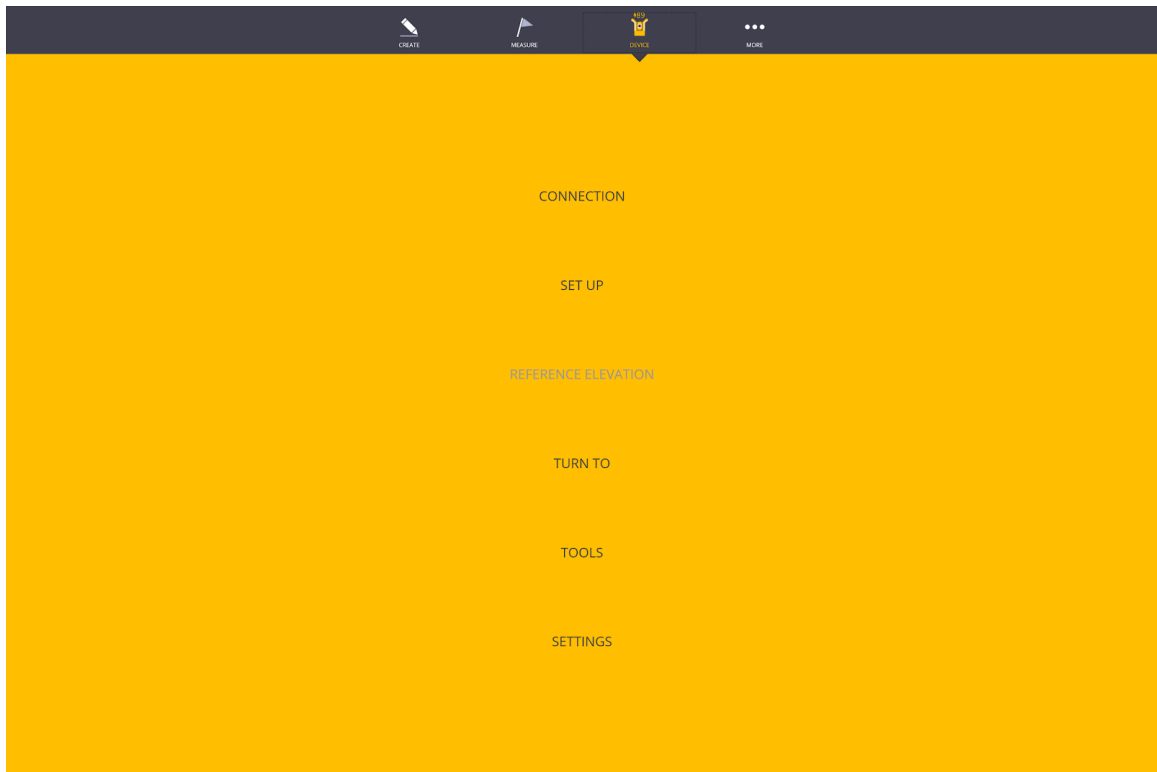

2.1.4 More

More is where users can select additional Modes such as Map, Projects, Reports, Trimble Connect, plus select functions About, Minimize, and Exit.

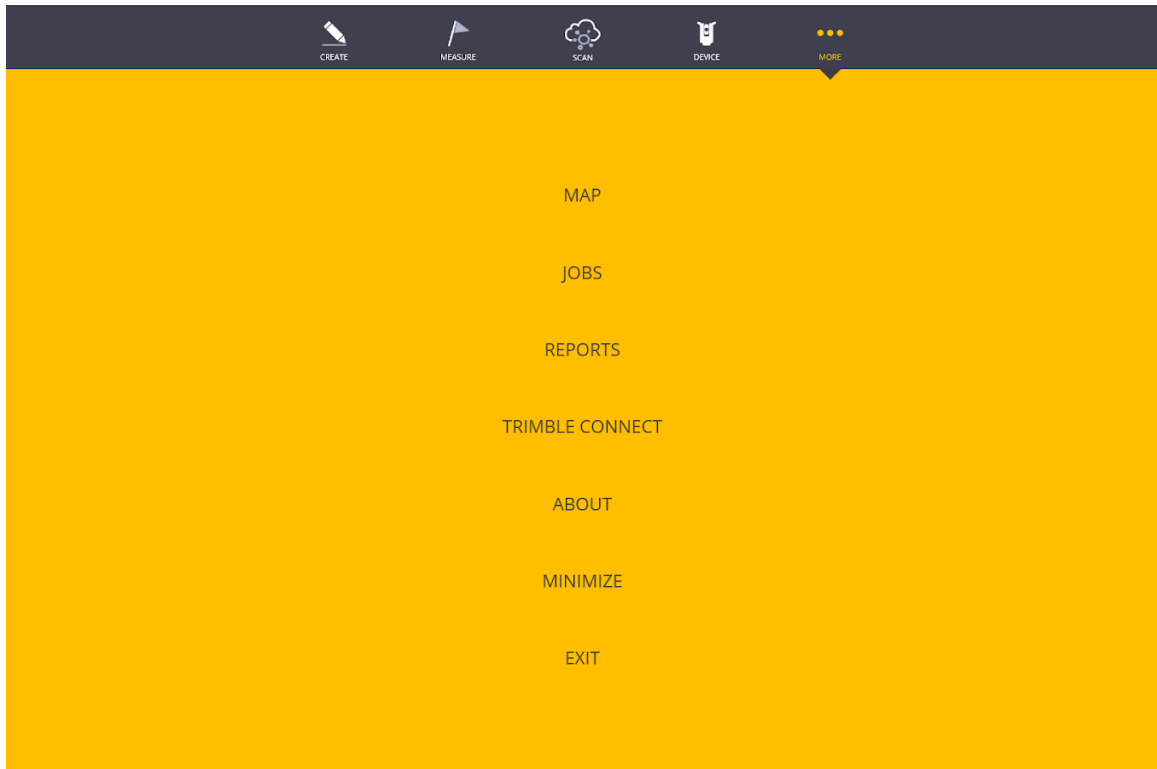

2.1.5 Map

Map is where you can go directly to map view of your model on the entire screen. You can also move, scale, or rotate models and background files in FieldLink Office under Map.

2.1.6 Projects

Projects is where users can open or create job files, import and export data, and change overall job settings such as displayed units, coordinate type, language & clearing layout flags for previously laid out points.

2.1.7 Reports

Reports is where users can create and view a daily layout summary, layout deviation, field report or report on surfaces collected.

2.1.8 Trimble Connect

Trimble Connect allows the project team to view, transform drawings and BIM data in your web browser without running design software. Upload and share 3D and 2D documentation with the entire team including SKP, DWG, DXF, PDF, Word, Excel, pictures, and videos with auto-archiving of all previous versions.

You can measure, create model clash reports, save markups and screenshots, and assign tasks to collaborators.

2.1.8.1 Status Sharing

With FieldLink and the Project Management Module, you can utilize the **Status Sharing** tool to show the progress of the various model components. The **Status Sharing** tool can push progress information to Trimble Connect Desktop or Tekla software with the installation of the Status Sharing extensions from those applications. See Section 8 for more information on Status Sharing.

Trimble Connect’s Sync Tool helps you keep a local copy of all your critical project data right on your computer or automatically upload it to the cloud for safe storage. Once connected, you can upload or download FieldLink jobs, models, point files, and reports from your Trimble Connect project when you have Wi-Fi service. You may also be able to use your cell phone to create a Wi-Fi hotspot while out in the field, depending on available cellular signal. Creating a Trimble Connect project is quick, easy and free for a personal project with up to 10GB of data storage. Training documentation, help files and more information can be found at: Connect.Trimble.com.

2.1.9 About

About allows the user to access the program information such as FieldLink Versions and Modules installed, Device Firmware Version (when connected), Legal Notices, Tablet Serial Number, and Software Support Expiration. This page has also been slightly reorganized for Term licensing.

2.1.10 Minimize

Minimize minimizes the program to the taskbar.

2.1.11 Exit

Exit is where you exit/close the FieldLink program.

2.2 Map Controls

The Map Control icons are shown along the right-hand side of the screen and allow the user to navigate within the existing project. Tap these icons once to activate the Map Control and tap again to disable the Map Control options.



2.2.1 Zoom Extents and Preset Views

The Zoom Extents and Preset Views icon is used to set the map extent to include all objects in the job, get a plan view, side view, or isometric view.

1. Tap the **Arrow Button** to the left of the **Zoom Extents** icon.
2. Select **Zoom Extents, Isometric, Side View** or **Plan View Button** to change the project view to the desired position.



2.2.2 Pan/Orbit

1. Tap the **Pan** icon to change to the Orbit icon and mode. You can then rotate around the center of your pen or finger.
2. Tap the **Orbit** icon to change back to the Pan icon and mode. You can then hold the existing view and move around the project in that fixed view.



2.2.3 Slider

The **Slider** icon allows the user to zoom in or out manually by operating the Slider Bar without utilizing touch controls.

1. Tap/Hold/Slide **Zoom** icon up or down to zoom in or out of the view.
2. Alternatively, use two fingers to pinch together or in/out figure gesture to zoom in/out.



2.2.4 Point List

The **Point List** icon can be utilized to create a point list for export, editing or layout sessions. You can add points to the list by selecting them individually on the screen, using the Window or All Visible selection tools. The point list can be created quickly by tapping on the **Plus** icon to filter by Name, Description or Layer. To edit the list, tap the X icon to the right to delete points from the list, or simply select new points to add to the list. To clear the list, tap the **Clear** icon. This icon is found under the Measure > Lay Out tool.

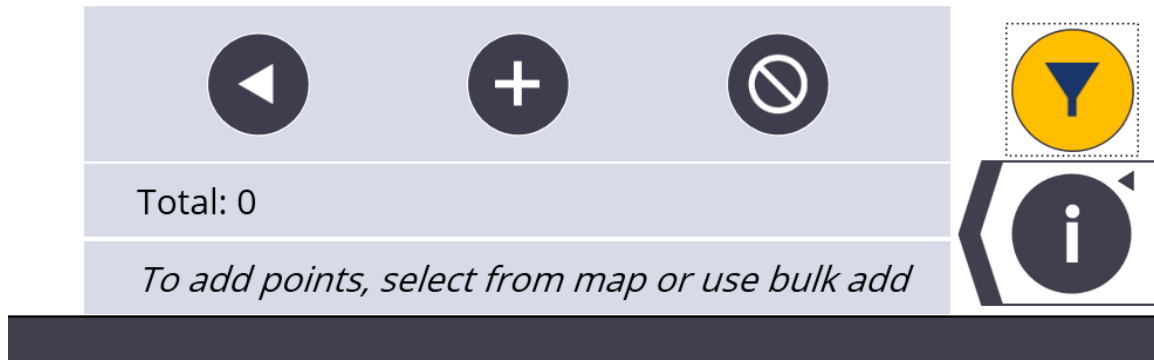

Press the Left Arrow icon to expand the point list and be able to review each point's information including layer, coordinates, staked information and attributes. This will also allow you to sort the point list by Name, Layer, Description, or Delta Horizontally or Vertically for staked points.

				Sort by	
				Name	
<input type="radio"/>	100	0	---	---	
Layer: 0		Attribute 1: ---			
X: 307.325 ft		Attribute 2: ---			
Y: -53.694 ft		Attribute 3: ---			
Z: 0.000 ft		Attribute 4: ---			
		Attribute 5: ---			
<input type="radio"/>	101	0	---	---	
<input type="radio"/>	102	0	---	---	
<input type="radio"/>	103	0	---	---	
<input type="radio"/>	104	0	---	---	
<input type="radio"/>	105	0	---	---	
<input type="radio"/>	106	0	---	---	
<input type="radio"/>	107	0	---	---	
<input type="radio"/>	108	0	---	---	
<input type="radio"/>	109	0	---	---	
<input type="radio"/>	110	0	---	---	
<input type="radio"/>	111	0	---	---	
<input type="radio"/>	112	0	---	---	
<input type="radio"/>	113	0	---	---	
<input type="radio"/>	114	0	---	---	





The **Information Zipper** icon is used to access the Information icon, Map Settings icon, the Layer icon, and the Section View icon.



2.2.5 Information

The **Information** icon allows the user to see information about a selected point such as Name, Description, Layer, and Coordinate Values. You can also press on straight linework to see the length and slope angle information as well as arc information such as length, diameter and slope angle. If you have an IFC model, you can also see the attached object information such as component name, size, volume or other information attached to the model object in programs such as Tekla or other BIM applications.

Information

1. Tap arrow to the left of the **Information** icon.
2. Select a Point, Line, Arc or object on the map.
3. Information is displayed on the map.
4. Tap **Info** icon to close.

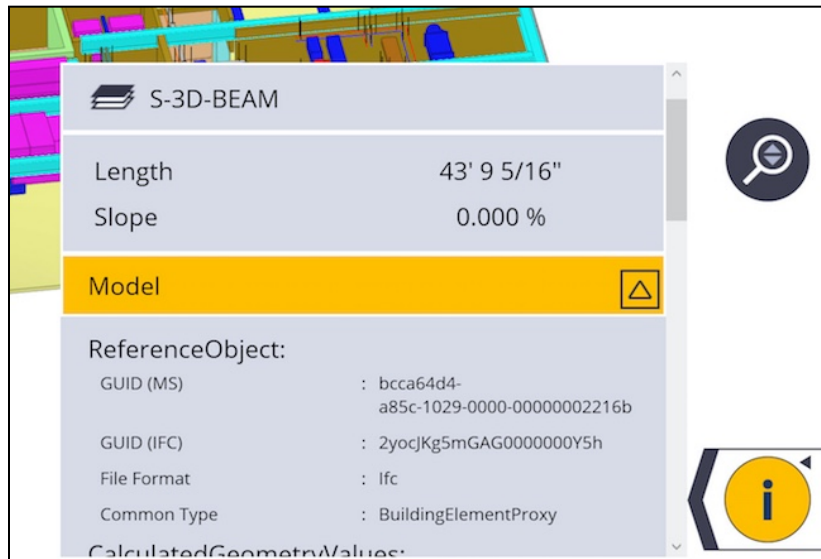

2.2.6 Map Settings

The **Map Settings** icon gives the user the ability to make point information such as Name, Description or Elevation visible on the screen. Options to remove points from view once they have been laid out, add a scale bar to the map, utilize a corner bullseye mode, view solid or wireframe models and set to travel direction when in layout mode can be checked on or off. The user can also change the background color to White, Black or make all linework Blue for better visibility in certain conditions.

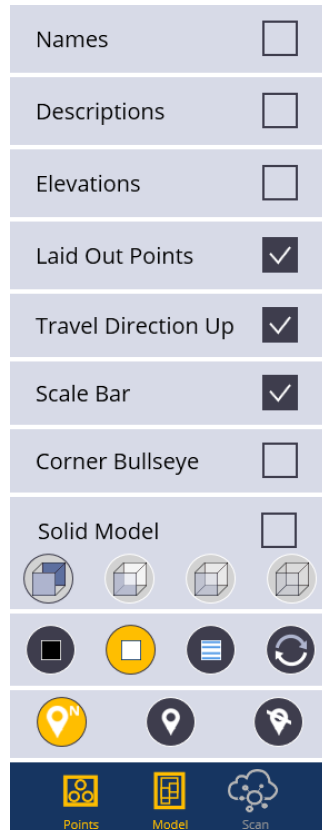

Map Display Options

1. Tap the **Arrow** next to **Info** icon.
2. Tap the **Map Settings** icon.
3. Make selections to display **Point Name, Point Description, Point Elevation, Laid Out Points** (If unselected, points will disappear off the screen once they have been laid out), **Travel Direction Up** (map rotates and updates as you walk to the point - Blue Diamond indicates travel direction) ,

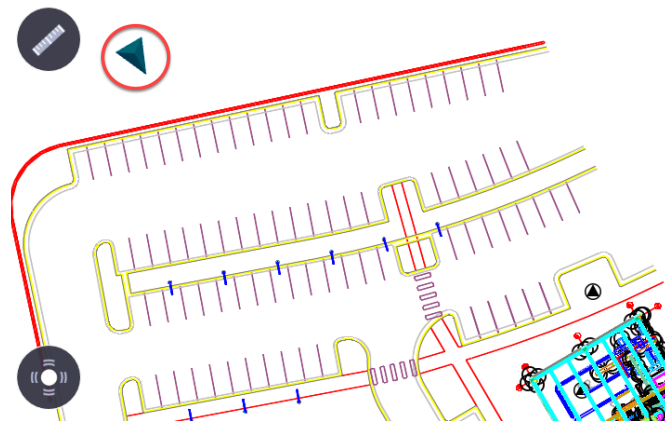

Scale Bar, and **Corner Bullseye** (Shows a corner bullseye option and full map screen while laying out points, lines or arcs).

4. You can also change from **Wireframe** to **Solid Model**, and various levels of **transparency** for the solid models.
5. Change the **Background Color** to Black, White, White with all blue line work, or the arrow button to cycle between various other color backgrounds.
6. The **Points** and **Model** icons allow you to toggle these options on or off. Yellow being on, white being off.
7. Tap the **Display Settings** icon to close the menu.



2.2.7 Layer

The **Layer** icon brings up a list of all available layers within the project and allows the user to display or hide individual layers. Once the **Layer** icon has been pressed, the user can tap on the displayed linework or points in the plan view and the program will highlight the associated layer in the layer list.

Layer Control

1. Tap the **Arrow** next to **Info** icon.
2. Tap the **Layer** icon
3. Select **Layers** to be displayed. You can tap on a line or item in the project to highlight a layer in the list view, or tap on a layer in the list view to highlight a layer in the map view.
4. **Filter** can be used to find layers containing specific text.
5. Tap **Plus** icon to create a new layer directly in the list view.
6. Tap the **Filter** icon to create custom layers with several layers displayed automatically.
7. Tap the **Layer** icon to close the menu.

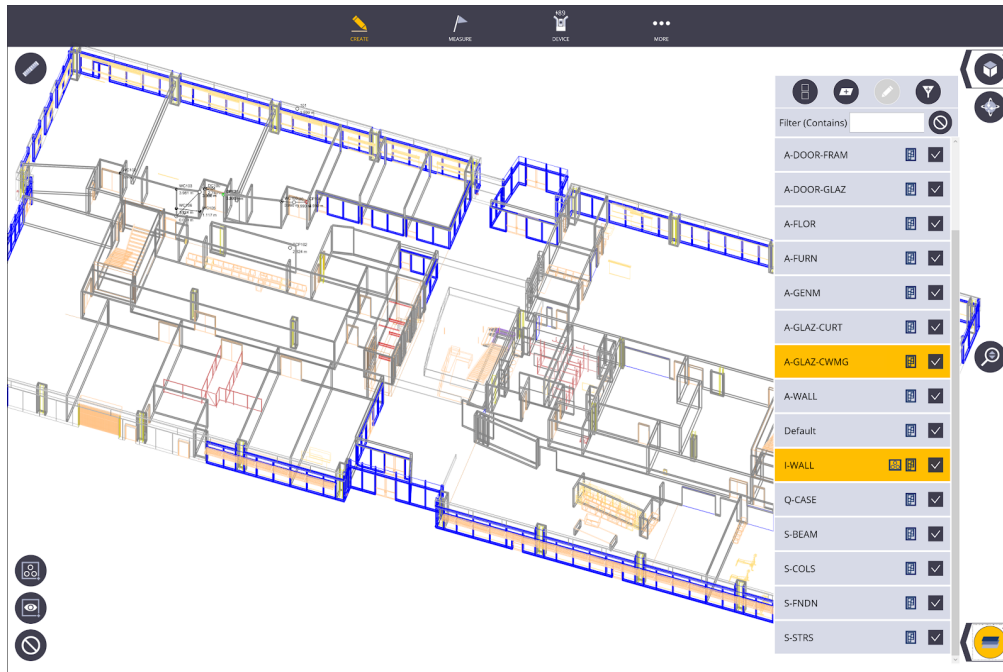

Save Layer View

To create a view that has specific layers turned on that you might utilize later:

1. Select the layers you want to view
2. Tap **Layer View** icon



3. Enter **Name** for view and tap **Create**
4. The view is now available in the layer filter list for selection



5. Note that you can replace existing Layer Views by creating a new Layer View and giving it the same name as an existing Layer View with 6.0 release.

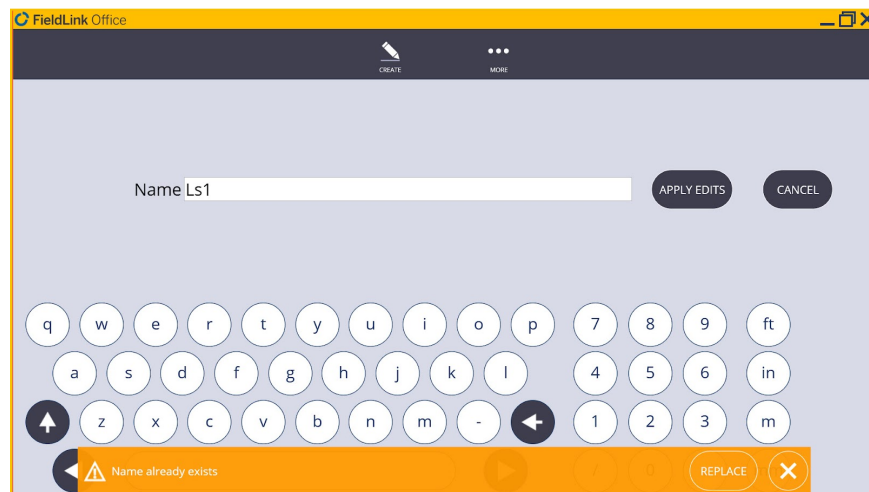



2.2.8 Section View

The **Section View** icon allows the user to set a six-sided view cube to focus on a certain area, and also save those section views.

1. Select the **Section Box** icon to activate the Section Creation box.
2. Tap the **Plus** icon and then *Name* your view.
3. Select the **Plus** icon to activate the six-sided section box around your model.
4. Tap and hold on any of the six side arrows to push or pull the section pane to a certain area. This section box will limit points created to the area within the box only.
5. Tap the **Reset** icon to take the Section cube to the original size.
6. Tap the **Edit** icon to change the name or input Top and Bottom Elevations directly.
7. Tap the *Section View* layer or press the **Plus** icon to create a new section.
8. Select the activated yellow Section then the Section icon to close this feature.

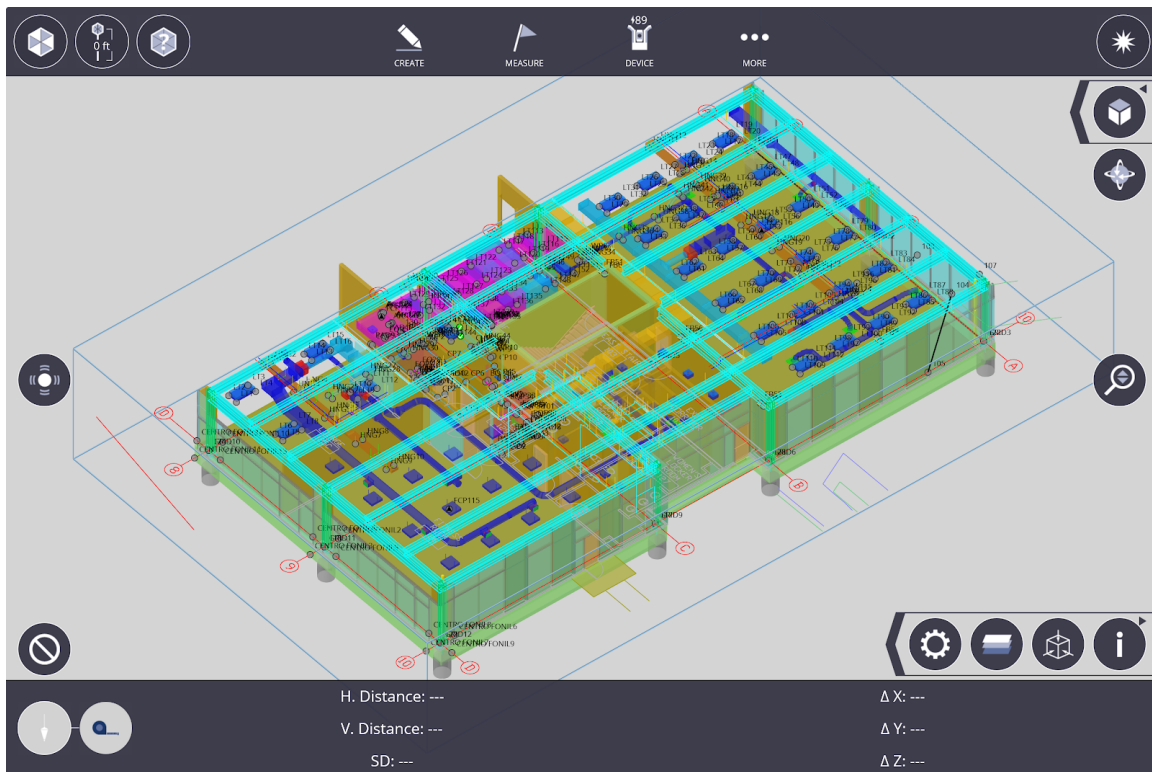

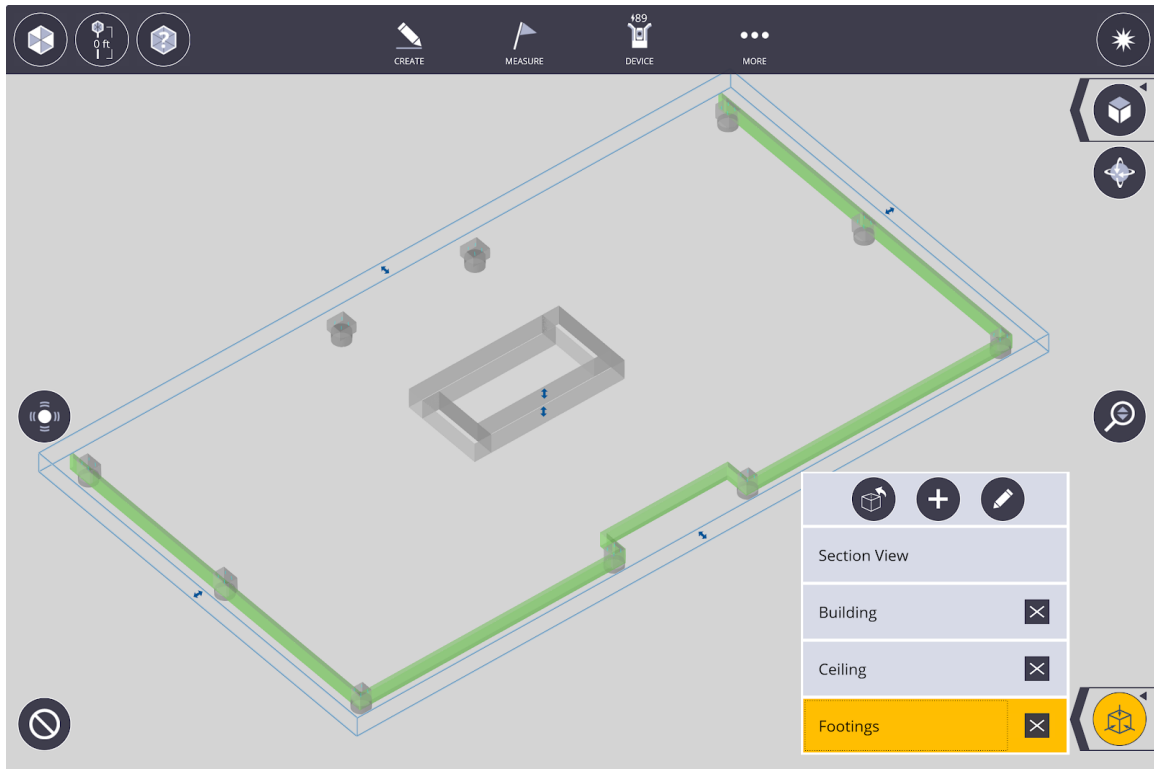

The screenshot shows a form for defining the parameters of a section view. The form includes the following fields and controls:

- Section View Name:** A text input field containing the text "Section 1".
- Top Elevation:** A text input field containing the value "38' 6 1/8\"".
- Bottom Elevation:** A text input field containing the value "-56' 2 13/16\"".
- SAVE:** A button located to the right of the Top Elevation field.
- CANCEL:** A button located to the right of the Bottom Elevation field.
- Keyboard:** A virtual keyboard is displayed at the bottom of the screen, featuring a QWERTY layout, a numeric keypad, and function keys like "ft" and "mm".



2.2.9 Model Management

The **Model Management** icon, found by unzipping the information zipper, brings up a list of all available models or background files within the project and allows the user to display or hide these models. The Model Management icon also allows you to transform, rotate and scale models and background files to fit another model or background file with common points. This is possible with both Field Link Office and Field versions.



Model Management icon also includes the trashcan option to delete the models/backgrounds files and the pencil option which allows you to edit, transform, rotate and scale models and background files. Below explains the edit function, its functionality and how to use it.

- 1) After selecting the Model Management icon, selecting one of the models from the list highlights that model in the project. Selecting the pencil/edit icon will allow you to edit that model.

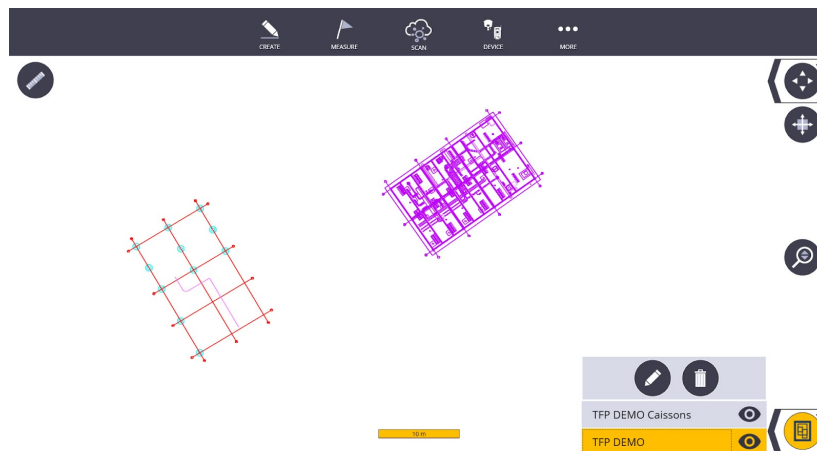

- 2) After selecting the pencil/edit icon, a page will populate with tools that allow you to edit the previously highlighted model. You can rotate the highlighted model with defined values or rotate and move the model anywhere in the project with the circular angle tool and mouse wheel.

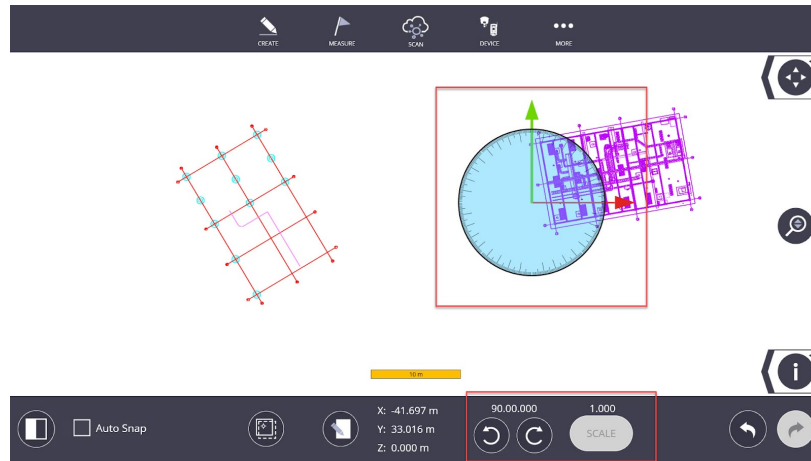

- 3) In the same page, there is an edit button that allows you to select a basepoint for the selected model if desired. This edit button also allows you to change the angle incrementation and the scale factor if desired.



- 4) Back at the first edit page, there is also a button that allows you to lock both models and move them simultaneously. This function doesn't allow for rotation.

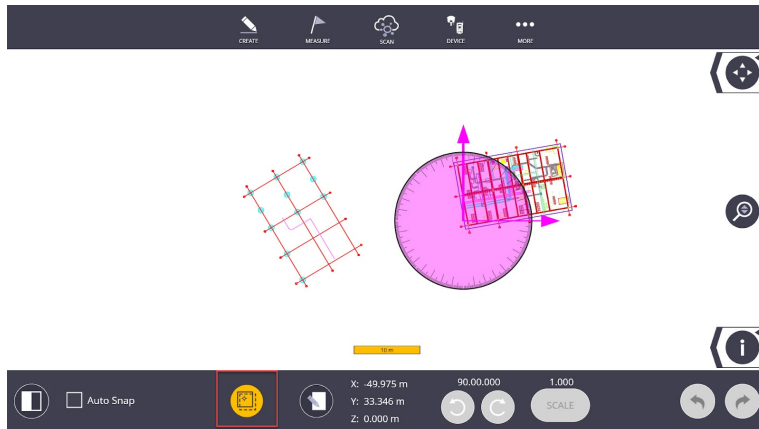

- 5) The final functionality is the button that allows you to fit your model to another model using common points in both models. Selecting the black/white icon brings you to a split screen with your selected model and the secondary model. At the bottom of this page there are three check boxes. One for auto snap which allows you to snap to points in both models, one for model scaling and finally, one to enable preview of the model fitting. There is also a rotation button that only becomes active after the 2 points have been selected in both models.

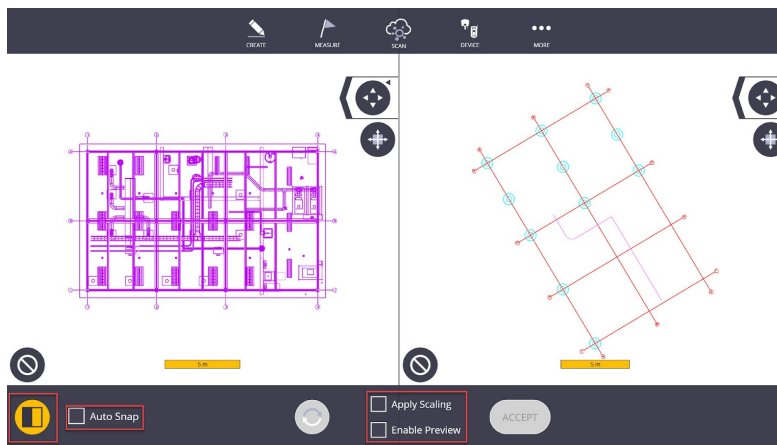

2.2.9.1 Transform, Rotate and Scale a Model to Another Model using 2 Points (Office and Field)

To perform the model fitting, from the split screen, select all three check boxes. Then select two common points between the models by selecting two points in your selected model, then selecting the same two points in the second model. If the model appears to fit but is off by 180 degrees, apply the rotate button at the bottom to rotate the model onto the other one. Once you are happy with the preview, select Accept which will fit your model to the other one. If you wish to redo the model fitting, before you select Accept, use the clear button in both models.

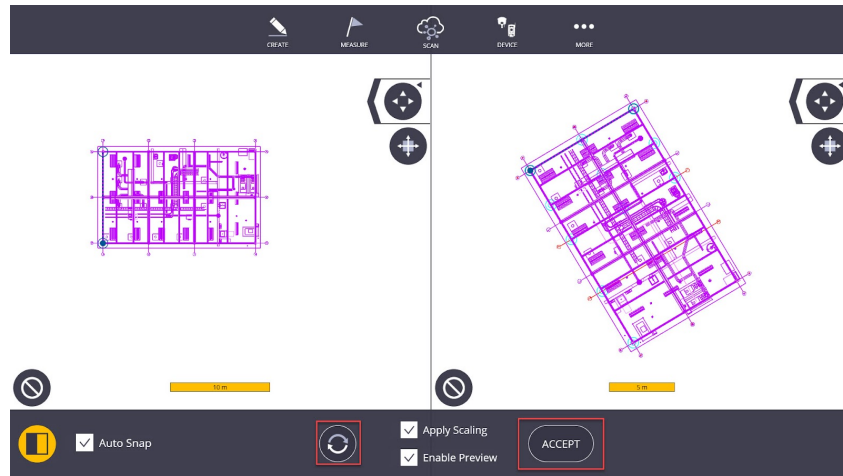

2.3 Workslate Area

The **Workslate** is the portion of the screen, containing user interface elements unique to the current **Work Mode**.



The **Input Form** is the area of the program where the user enters in any numeric, alphabetic, or layer information for the program to use. Input forms contain all variables that are used in the current **Work Mode**. Each **Work Mode** has its own individual input form.



The **Undo** icon allows the user to undo the last action taken such as creating, deleting or modifying points or linework.



The **Delete** icon allows the user to delete any type of point, or to delete linework created within FieldLink.



The **Create** icon will be available in specific **Job** and **Create Work Modes** to finalize the creation of items.

2.4 Map Tools



The **Clear All** tool is used to clear all selected points, lines, and arcs from the map view.



The **Window Selection** tool allows users to drag and draw a boundary, which selects everything inside the boundary for the current **Work Mode**.



The **Current View** tool is similar to the Window Selection tool but is used to select everything currently in view on the screen in lieu of drawing a boundary.



2.5 Compute Tools

The **Compute** button accesses the Distance, Angle, Area/Volume, and Down/Out features. The Compute Mode is designed to assist users by providing easy access to basic tools to compute geometry information from existing points.

2.5.1 Compute Distance

1. Tap the **Compute** icon in the upper left corner.
2. Tap on the **Distance** icon.
3. Tap on the first point you need a measurement from. The first point you select will be the starting point and indicated by a solid blue circle.
4. Tap on the second point for the measurement. The second point you select will be the end point and indicated by an open blue circle.
5. The measurement details between the two points are displayed in a yellow text box.

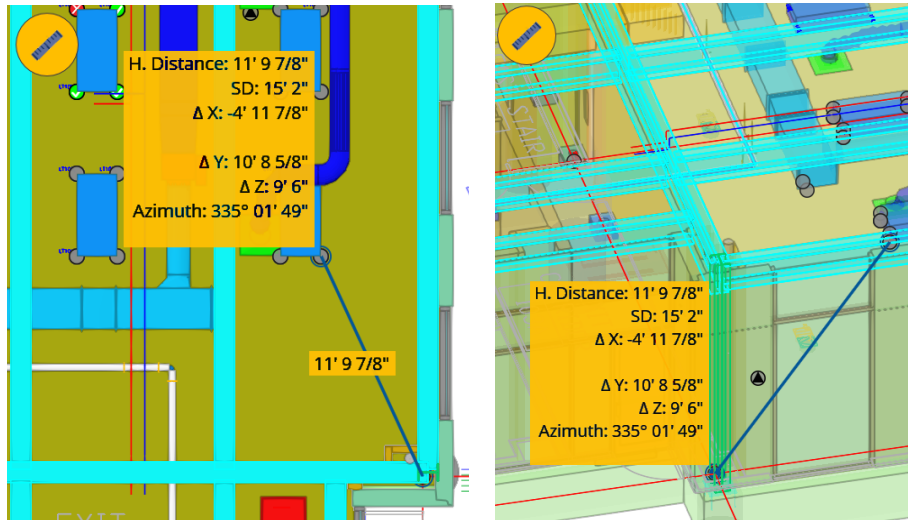

6. Select another endpoint. The original start point will remain.
7. Tap the **Clear** icon to measure between two new points.

2.5.2 Compute Angle

1. Tap the **Compute** icon in the upper left corner.
2. Tap the **Angle** icon.
3. Tap on the first point you need an angle measurement from. The first point you select will be the starting point and indicated by a solid blue circle.
4. Tap on the second point for the measurement. The second point you select will be the angle point and indicated by a solid blue circle.
5. Tap on the third point for the angle measurement. The third point you select will be the end point and indicated by an open blue circle.
6. The angle measurement between the three points will appear in the lower message bar.
7. Select another endpoint. The original start point and angle point will remain.
8. Tap the **Clear** icon to measure between three new points.

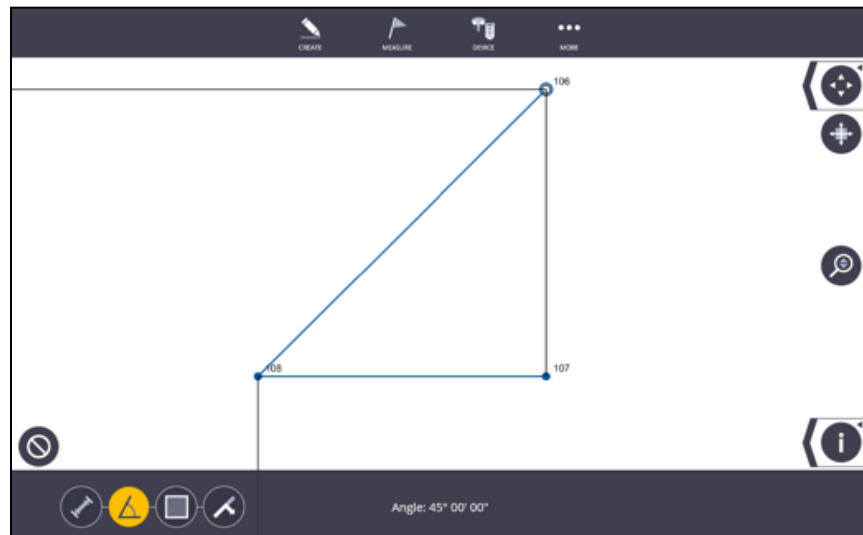

2.5.3 Compute Area & Volume

1. Tap the **Compute** icon in the upper left corner.
2. Tap the **Area** icon.
3. Tap on the first point to outline the area you want to compute.
4. Tap on the second point to outline the area you want to compute.
5. Tap on the third point to outline the area you want to compute. The third point you select will cause a dotted blue line to be created between the start point and the third point and defines an area. Once a three-point boundary has been established, the area and perimeter will be shown in the lower message bar.
6. Continue to tap on the additional points to outline the area you want to compute. Each point you select will cause a dotted blue line to be created between the start point and the last point selected.
7. If you accidentally select a point, tap on the point again to deselect the point. The last selected point will appear as an open blue circle. You can deselect as many points as necessary.
8. Tap on the **Input Form** icon and enter a *Depth* dimension.
9. The Area, Volume and Perimeter calculations are shown in the lower message bar.
10. Tap the **Clear** icon to start a new Area calculation.

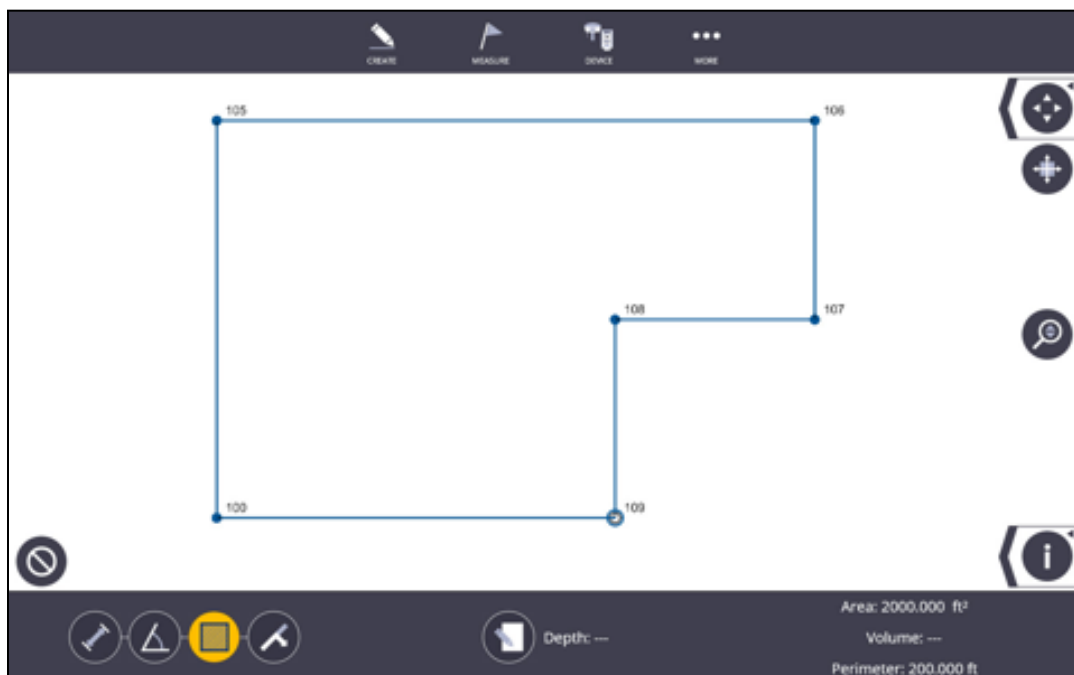

2.5.4 Down and Out Calculation

1. Tap the **Compute** icon in the upper left corner.
2. Tap the **Down & Out** icon.
3. Tap on the first point of the line you need a measurement from. The first point you select will be the starting point of the line and Down measurement.
4. Tap on the second point of the line you need a measurement from. The second point you select will define the line for the Out measurement.
5. Tap on the third point to calculate the Down and Out measurement. The third point you select will be indicated by an open blue circle and attached to the main line with a perpendicular line.
6. If you accidentally select a point, tap on the point again to deselect the point. The last selected point will appear as an open blue circle. You can deselect as many points as necessary.
7. The Down and Out measurement between the three points will appear in the lower message bar.
8. Select another third point. The original line start point and end point will remain.
9. Tap the **Clear** icon to measure between three new points.

3. Projects

FieldLink **Projects** allows you to **Open** or **Create** Jobs, **Import** drawings, models and point files, **Export** project data including points or created linework, and modify Job **Settings** such as Distance Units, Coordinate Order and Languages.

3.1 Creating a New Project

1. Select **More** then **Projects**
2. Select **Manage**
3. Select **Create New**
 - a. Type **Name**
 - b. Type **Description** (*optional*)
 - c. Add: layout job and/or scan job (if enabled)
4. Tap **Open**
 - a. Takes you to the map



Note: Go to the 'Tree' button to see file structure.

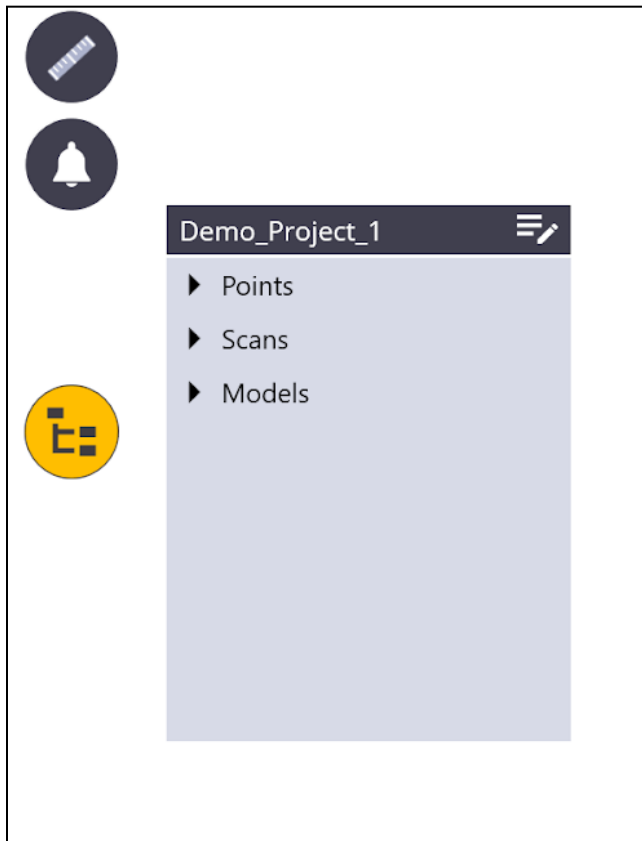
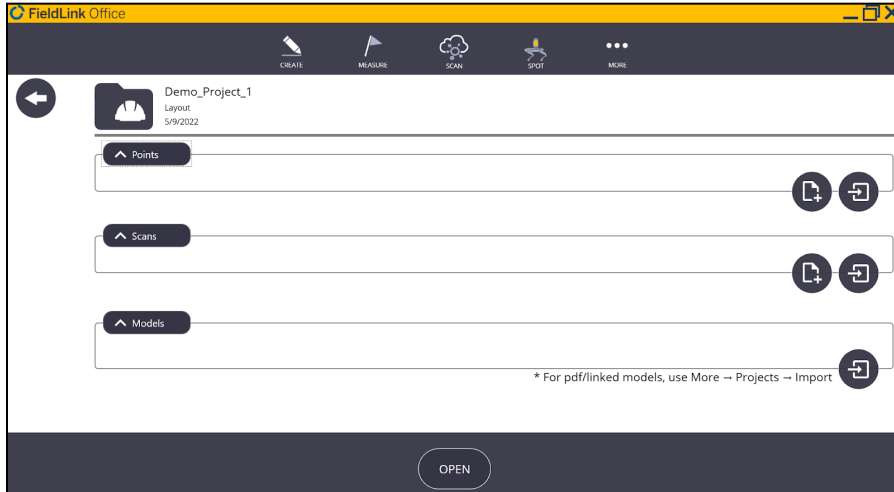

3.2 Steps to create a TFLX file

1. Use the **Create** tools in FieldLink to **create points**
2. **Convert** an existing TFL file to TFLX
3. **Import** a CSV or TXT file

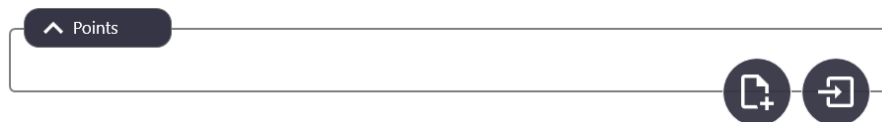

3.3 Converting Existing TFL Files from Previous FieldLink Versions

1. Select **More**, then **Projects**
2. Select **Convert**
3. Navigate to and select the desired .TFL file and select it
4. Select **Convert**
5. A TFLX project is created and opened
 - a. FieldLink will automatically create a scan or layout job in this new file



3.4 Importing Files

1. Tap the **More** icon
2. Select **Projects** and then **Import**
3. Navigate to and select the desired file

Note that the File Explorer structure is different from previous versions of FieldLink. Projects have their own folder within the FieldLink folder.

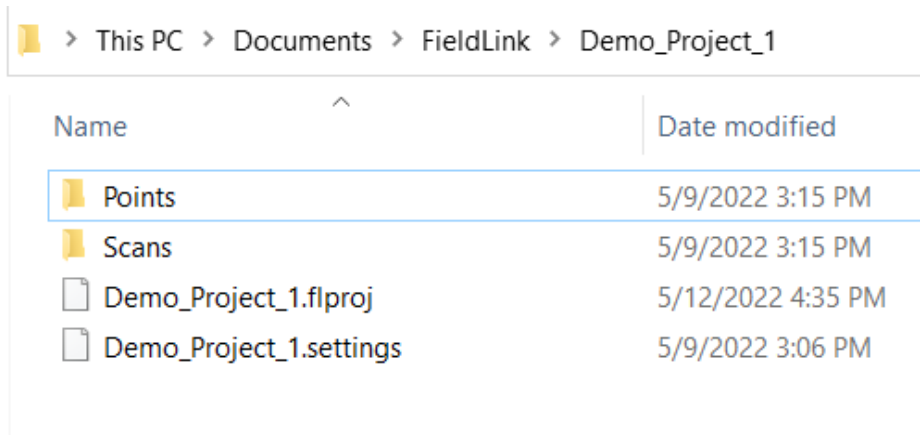

4. Tap **Import**

3.4.1 Steps to Import a Model or PDF into a Project

1. Tap the **More** icon
2. Select **Projects** and then **Import**
3. Navigate to file location
4. Tap **Import**

Alternative workflow

1. Tap the **More** icon.
2. Select **Projects** and then **Manage**.



3. Under the Current Project, tap the **Edit** icon
4. Tap the **Import** icon under the **Models** section
5. Follow steps above for regular workflow
6. Tap **Apply**



* For pdf/linked models, use More → Projects → Import

3.5 Exporting Data

1. **Open** your project
2. Select the points on the map that you wish to export
3. Select **More** then **Projects**
4. Tap **Export**
5. Select the **File Type** and **Export Point Location**
6. Tap **Export**

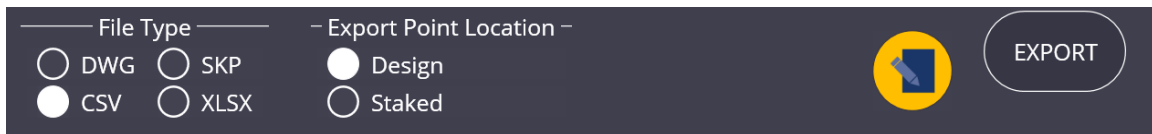



3.6 Managing a Project

1. Select **More** then **Projects**
2. Select **Manage**
3. Select a project and press **Open**

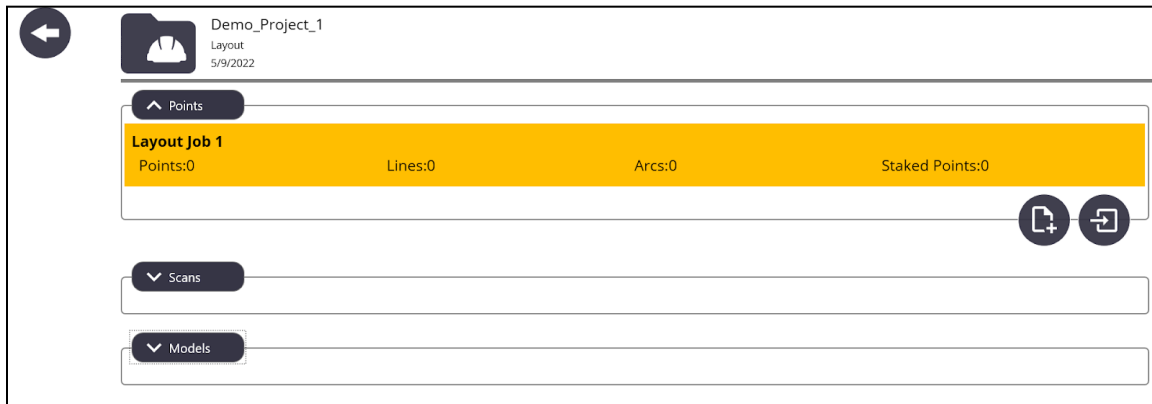

4. Create or **Add** point, scan, and model job files.



5. To **Create** or **Import** a points file select the appropriate icon:  
6. The created points file will be a .tflx and can be found in the project's Points folder (see Importing Files Section).
7. Once files are added, select **Open**
8. Points, scans, and models can be accessed using the tree button on the left side of the screen.

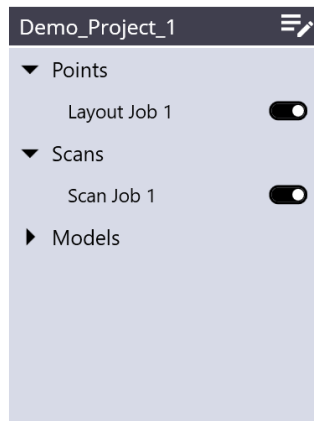

3.6.1 Deleting Job Files

To DELETE either a points, scans or models job file, make sure the job is not highlighted yellow (meaning it is not active in the project) and once grayed out, a trash can will appear on the far right side of the job file. Click on the trash can icon and hit yes to confirm you would like the file to be deleted.

3.7 Job Settings

Settings of the project including the **Distance Units**, **Coordinate Order**, **Language** and **Clear Layout Flags** can be modified under Projects.

1. Tap the **More** icon.

2. Select **Project** and then **Settings**.
3. Selecting **Distance Units** as Feet will show measurements in decimal feet. Selecting Feet-Inch (1/16") will show measurements to the closest 1/16". Meters are also available for metric projects.
4. **Coordinate Order** will change how points are imported or exported. Depending on the type of software used to create or import points, the points may need to be in (X,Y,Z) or (N,E,Z)= (Northing(Y), Easting(X), Elevation(Z)).
5. Several different languages are also available including English, Spanish, French, Dutch, German, Italian, Portuguese, Japanese, Korean and Simplified Chinese.
6. To reuse the layout point locations without the attributed detail of the already positioned data then you can tap on the **Clear Layout Flags** button.

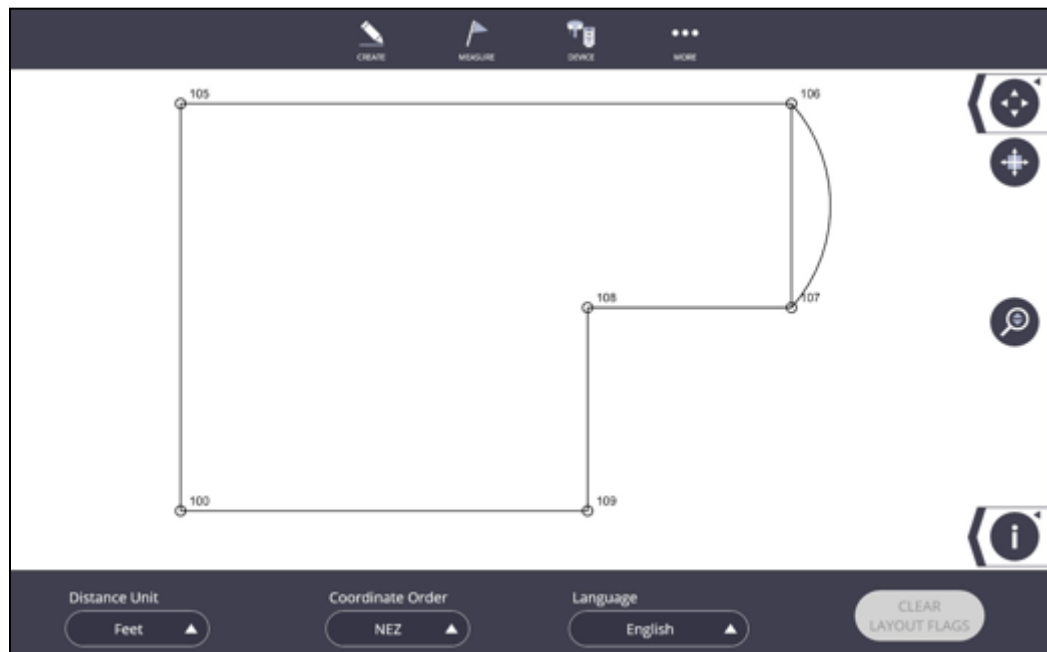

4. Create Mode

Create Mode allows you to create, modify or delete points and linework in your project. No modifications can be made to imported drawing or model files.

4.1 Point Manager

In the Points work mode, users can view point information, add, edit or delete points, or specify select points as Control Points. You also can create Points along a line or arc, or offset points along a line or arc to either or both sides of the line or arc.

4.1.1 Input Point

1. Tap the **Create** icon.
2. Select **Point Manager**.
3. Tap the **Input Form** icon.

4. Input the **Name**, **Description**, **Layer**, **X(Easting)**, **Y(Northing)**, and **Z(Elevation)** of the point that will be created. Place the points on a specific layer by tapping the Layer drop-down menu, or type in a new **Layer** to create a new layer name.
5. Checking the box next to **Control Point** will mark the point with a triangle in the middle of the point to signify it is a **Control Point**.
6. Tap the **Create** icon.

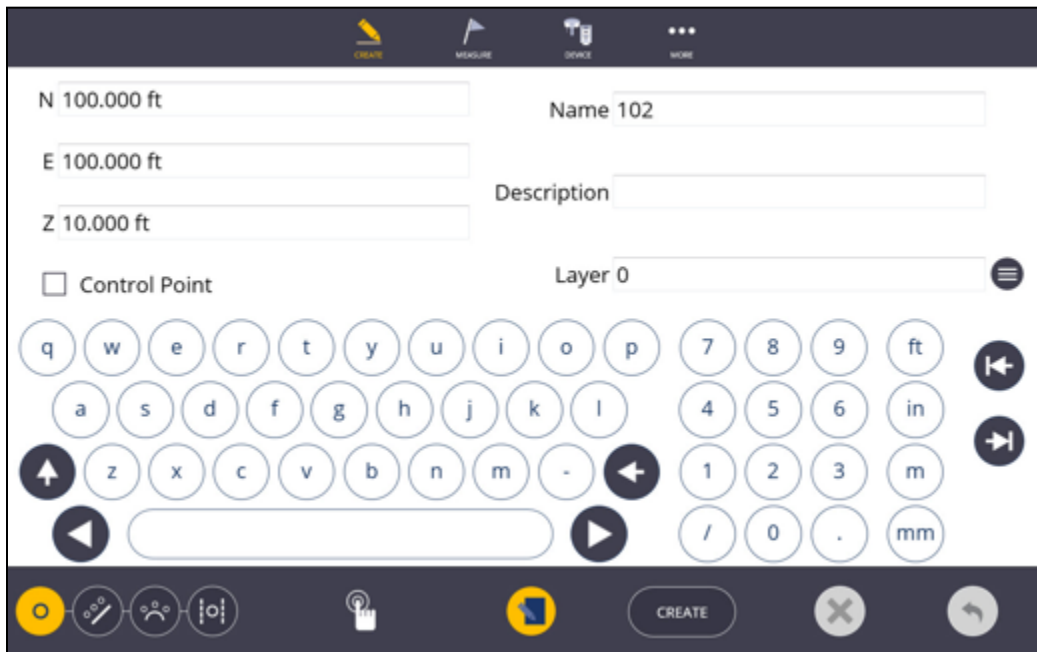

7. To edit a single point or multiple points, tap on one of the existing points to highlight it in blue or use the **Window Selection** tool.
8. Use the **Map Tools** to zoom in on an area, zoom extents, turn on/off layers, or otherwise define a single or group of points to edit simultaneously.
9. Unselect the point by tapping it again or tap the **Clear All** icon to unselect all points.
10. Tap the **Input Form** icon. You can change the **Description**, **Layer**, **Z(Elevation)**, or make them **Control Points**. You can change the **X(Easting)**, **Y(Northing)** only for single points at a time.
11. If you edit the **Name** of an existing point, the **Name** will revert to the next number available in the sequence and the position values, layer and description will be the same as the selected point. This process is similar to a "Save As" function.
12. Tap the **Apply Edits** icon.
13. You can delete single or multiple points by selecting the point and tapping the **Delete** icon.
14. Tap the **Undo Arrow** to undo the last creation, edit or delete process.

4.1.2 Create Point Anywhere

1. Tap the **Create Point Anywhere** icon and then tap the screen where you want to place the point. This option should only be utilized when no background option will work or for temporary points.
2. You can then edit this point using the **Input Form**.

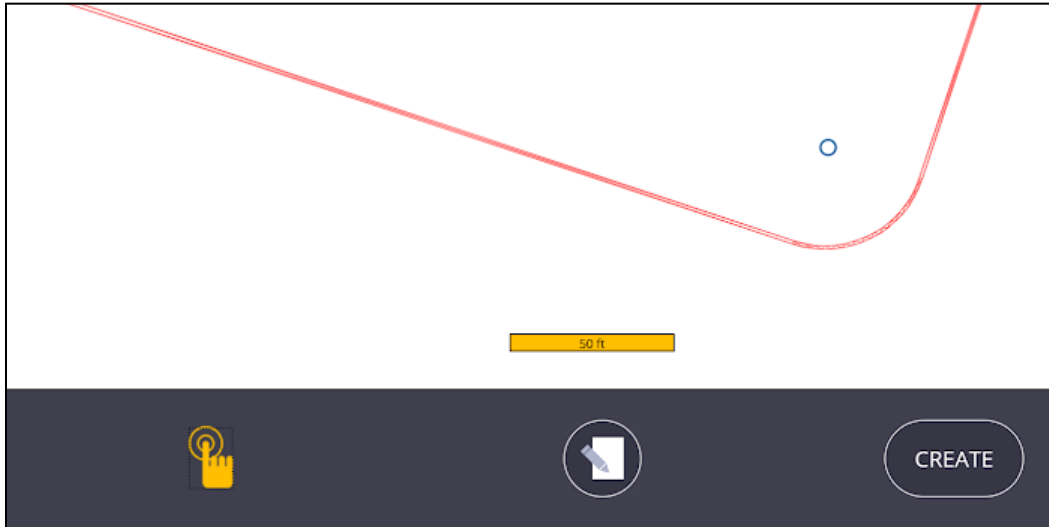

Tip

Use the **Create Point Anywhere** tool along with the Scanning module to create layout points along building corners, wall lines or other recognizable scanned objects.

4.1.3 Single Point Offset

1. Tap the **Line Offset Point** icon and select the start and end point of the line you want to offset or create points along.
2. Select the **Single Mode** option
3. Select **two points** to define direction
4. Tap on **Input form** and **enter values** for Horizontal Offset, Vertical Offset, Start Distance, Name, Description and select or enter layer. Tap on input form to return to map to check the location of point that will be created.
5. Tap **Create**

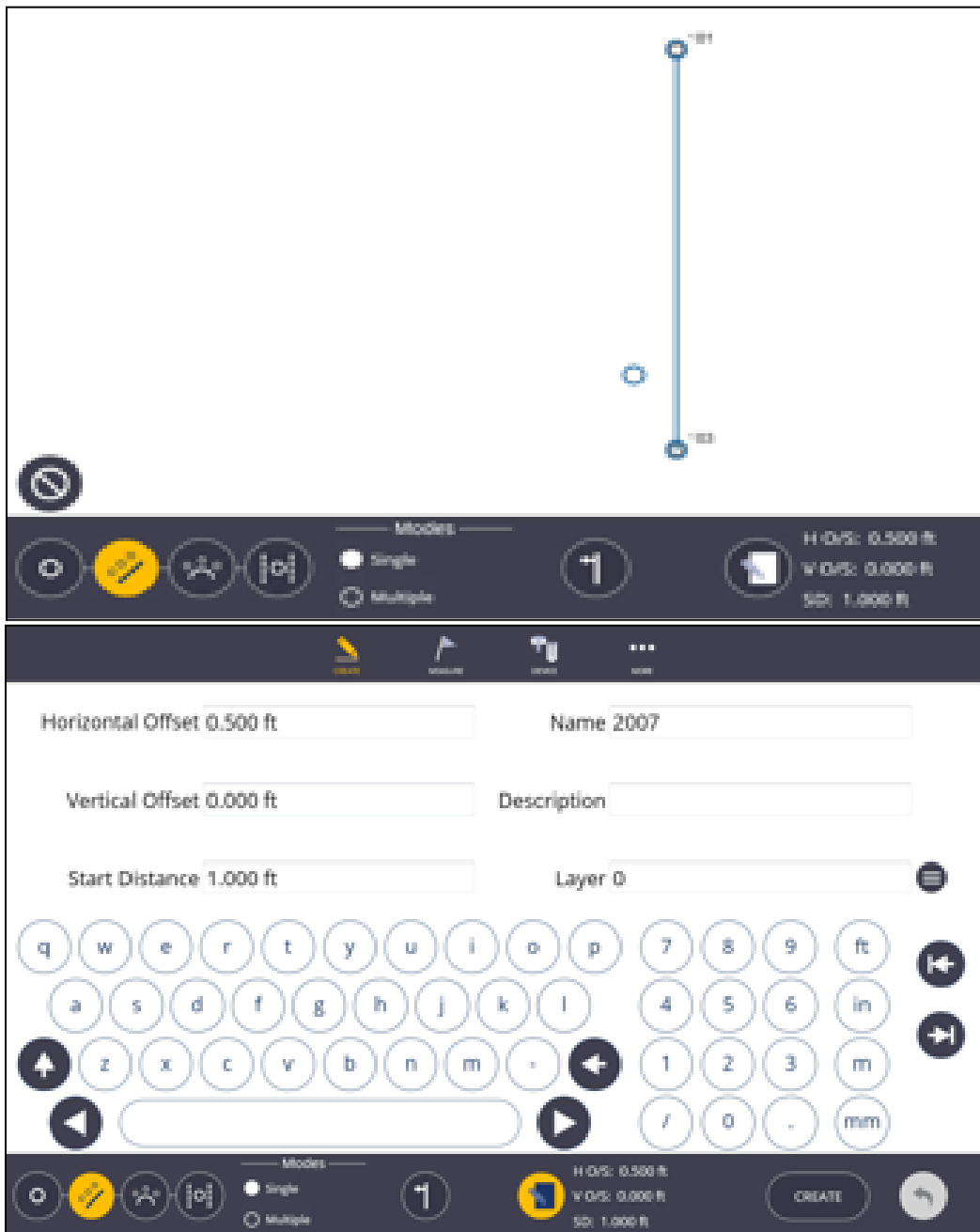

4.1.4 Create Multiple Offset Points - Line

1. Tap the **Line Offset Point** icon and select the start and end point of the line you want to offset or create points along.
2. Select the **Multiple Mode** option
3. Tap the **Input Form** icon. Input the **Name**, **Description**, **Layer**, **Offset Distance** (Can be "0" if you want points along the line), **Interval** (*Distance between points along the line*), and **Start Distance** (First point off the first point you selected). The elevation of the offset points will be determined by the *Z(Elevation)* of the points selected for the start and end points of the line. Place the points on a specific layer by tapping the Layer drop-down menu, or type in a new **Layer** to create a new layer name.
4. Tap the **Offset Direction** icon to toggle from Right, Left or Both Sides of the line prior to creating your points.
5. Tap the **Create** icon.



4.1.5 Create Multiple Offset Points - Arc

1. Tap the **Arc Offset Point** icon and select the start and end point of the arc you want to offset or create points along.
2. Tap the **Input Form** icon. Input the **Name**, **Description**, **Layer**, **Offset Distance** (Can be "0" if you want points along the arc), **Interval** (Distance between points along the arc), and **Start Distance** (First point off the first point you selected). The elevation of the offset points will be determined by the Z(Elevation) of the points selected for the start and end points of the arc. Place the points on a specific layer by tapping the Layer drop-down menu, or type in a new **Layer** to create a new layer name.
3. Tap the **Short Arc/Long Arc** icon to switch the new arc from the short arc solution to the long arc solution.
4. Tap the **Flip Arc** icon to switch the direction of the arc.
5. Tap the **Offset Direction** icon to toggle from Right, Left or Both Sides of the line prior to creating your points.
6. Tap the **Create** icon.
7. Tap the **Undo Arrow** to undo the last creation, edit or delete process.

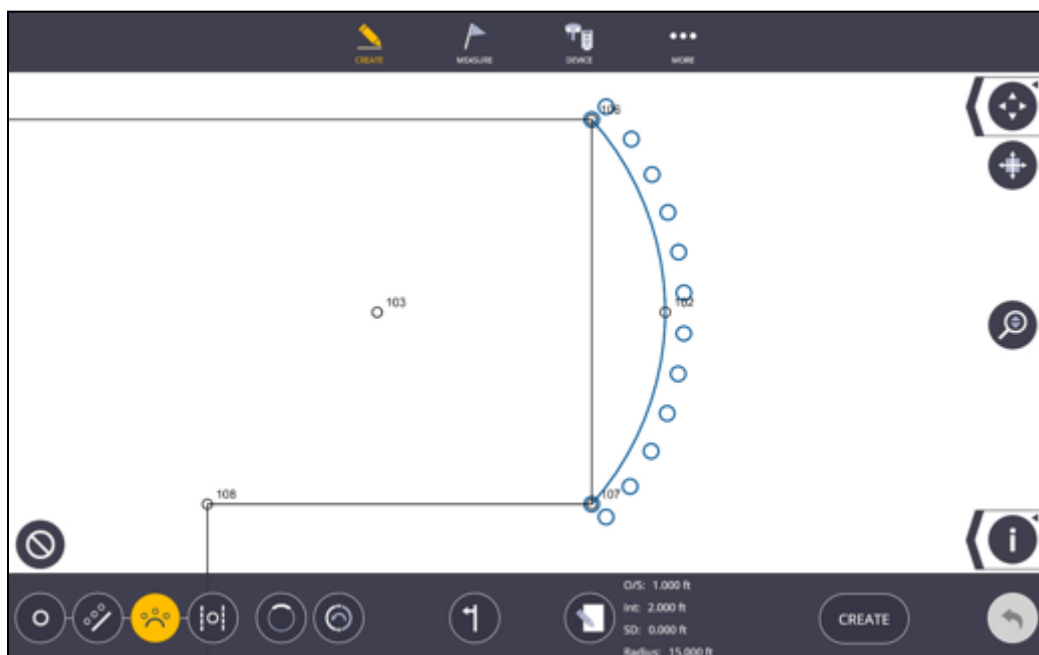

4.1.6 Create Point – In Wall

1. Tap the **Create Point in Wall** icon
2. Select the **two lines** that define the wall
3. Tap the **location** between the lines where you want to create the point
4. Tap the **Input Form** icon. Input the **Name, Description, Layer** (Place the points on a specific layer by tapping the Layer drop-down menu, or type in a new **Layer** to create a new layer name).

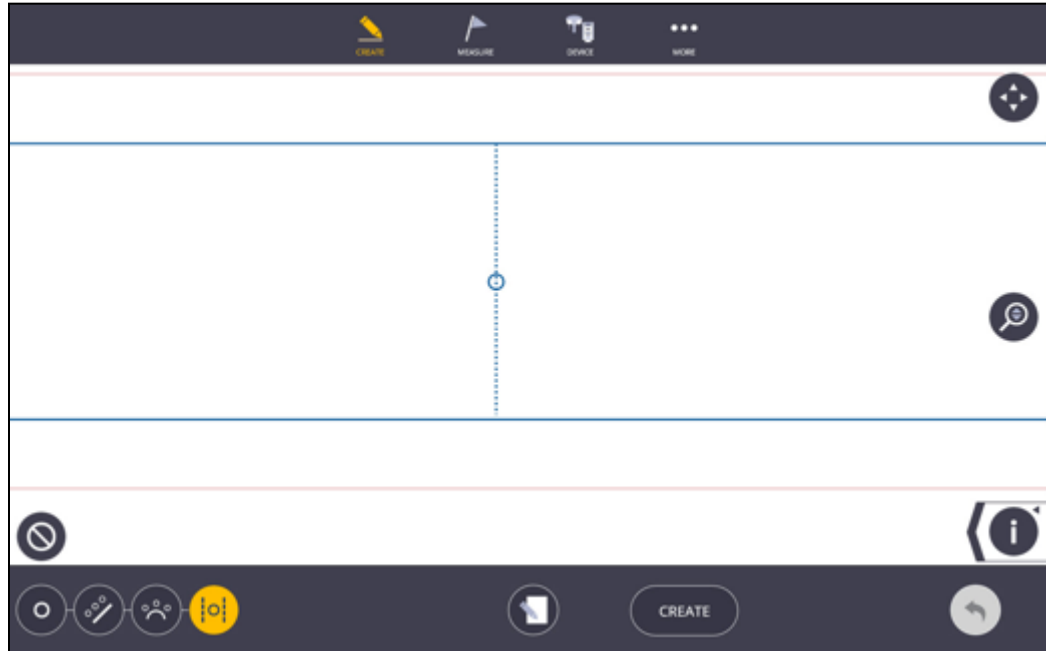

5. Tap **Create**

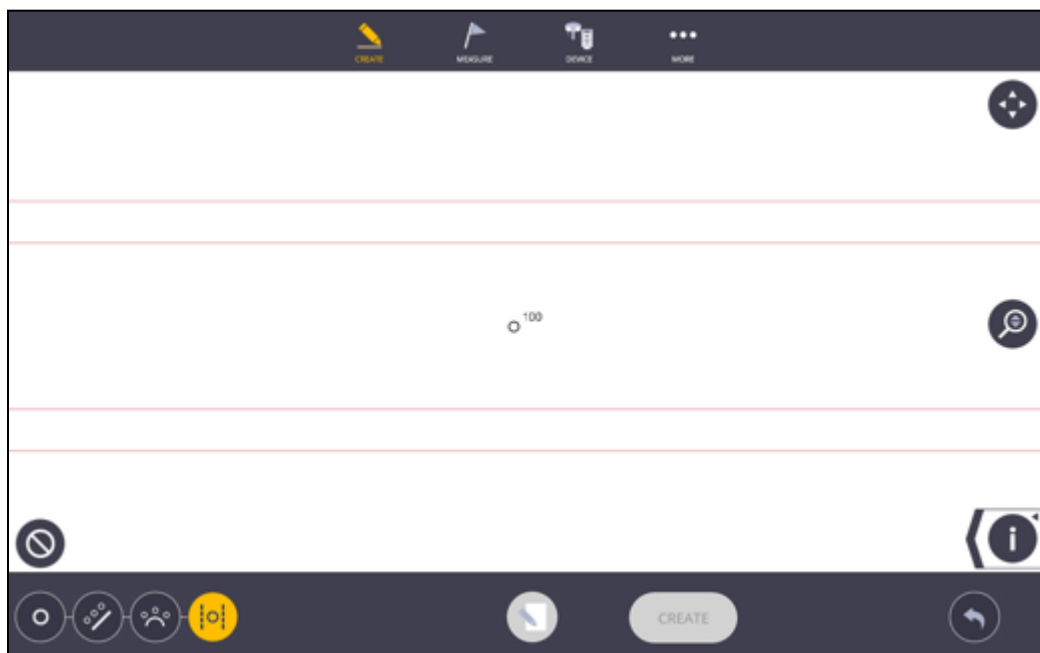

4.1.7 Point Manager

For location, review and editing of point data, FieldLink's Point Manager enables you to create a list based on map selection or by specific filter fields. A selected point in list will be highlighted in the map view.

1. Tap the **Point Filter** icon.
2. To populate the list either select points individually on the map area, multi-select points using the multi-select tool, or tap on the plus icon to populate the list by a filter selection (Name, Description, Layer, Design points, Control points).
3. To **review details** of a point, tap on the Left face arrow to expand the list.
4. You can arrange the order of the list by selecting the Sort by drop-down. Sort by Name, Description, Layer, Delta H and Delta V.
5. To review the details of a point, tap on the Down Arrow.
6. You can **make edits** to points by using the Enter Form. If you want to change a point name, you need to select the point, enter the new name, then press create. FieldLink will keep the original point, or you can delete it if no longer needed.
7. If you select a point in the list it will be highlighted in the map area
8. To clear the list tap on the **Clear** icon.



Note - If you have more than a single point in the list or selected on the screen, then edits will be made to all the points. When editing multiple points, you can only change the Elevation, Description, Layer, Attributes,

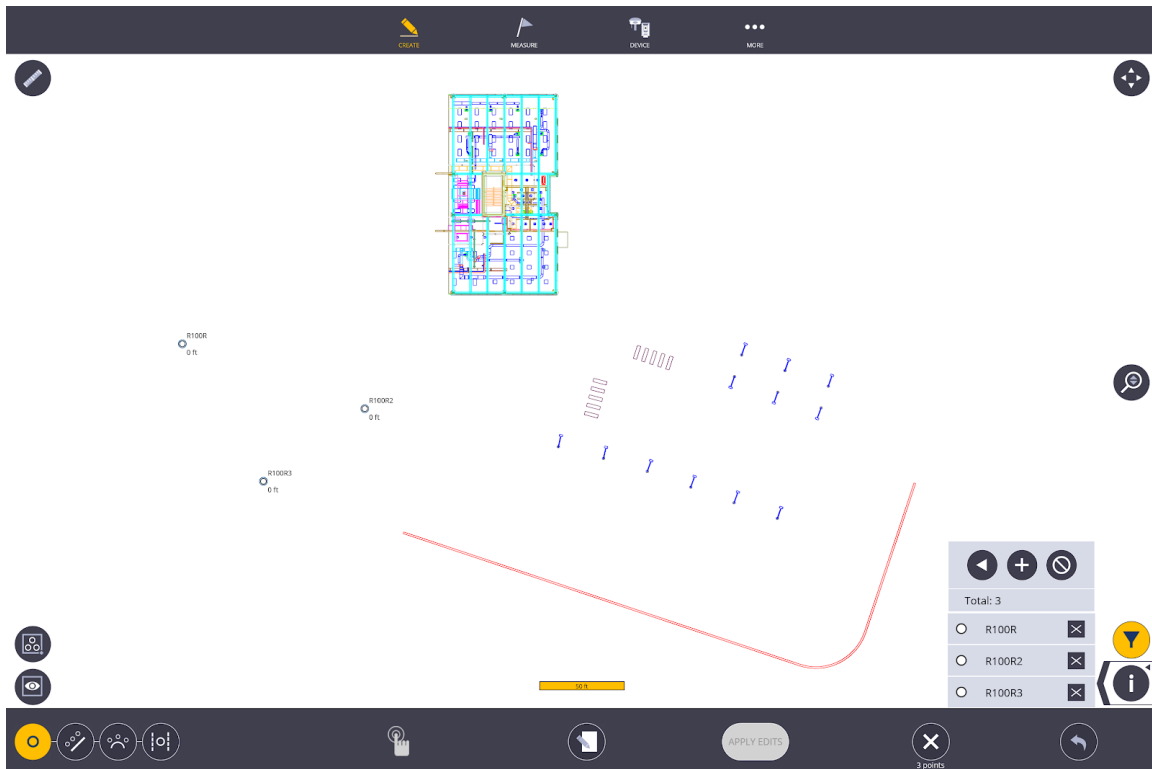

X *VARIES*
 Y *VARIES*
 Z 100.000 ft
 Control Point

Name *VARIES*
 Description Piers
 Layer 0-Pier Centers

1. Pier Type	24" Diameter
2. Rebar Cage	8 - #5 Bar w #3 12" OC
3. Embedment	8' Into Bedrock
4. Top of Pier	96'-0"
5. Anchor Bolts	N.A.

q w e r t y u i o p 7 8 9 ft
 a s d f g h j k l 4 5 6 in
 z x c v b n m - / 1 2 3 m
 / 0 . mm

		Sort by	
		Name	
<input type="radio"/>	R100R	Piers	0-Pier Centers
Layer: 0-Pier Centers		Pier Type: 24" Diameter	
X: 61.271 ft		Rebar Cage: 8 - #5 Bar w #3 12" OC	
Y: -19.895 ft		Embedment: 8' Into Bedrock	
Z: 100.000 ft		Top of Pier: 96'-0"	
		Anchor Bolts: N.A.	
<input type="radio"/>	R100R2	Piers	0-Pier Centers
Layer: 0-Pier Centers		Pier Type: 24" Diameter	
X: 168.266 ft		Rebar Cage: 8 - #5 Bar w #3 12" OC	
Y: -57.854 ft		Embedment: 8' Into Bedrock	
Z: 100.000 ft		Top of Pier: 96'-0"	
		Anchor Bolts: N.A.	
<input type="radio"/>	R100R3	Piers	0-Pier Centers
Layer: 0-Pier Centers		Pier Type: 24" Diameter	
X: 108.824 ft		Rebar Cage: 8 - #5 Bar w #3 12" OC	
Y: -100.401 ft		Embedment: 8' Into Bedrock	
Z: 100.000 ft		Top of Pier: 96'-0"	
		Anchor Bolts: N.A.	

4.2 Plan

The Create Plan mode allows the user to create a series of points and linework to draw out the desired floor plan, add linework to an existing 2D plan or 3D model, or create offset points and linework to any existing points or linework.

1. Tap the **Create** icon.
2. Select **Plan**.
3. Tap the **Input Form** icon.
4. Input the **Name**, **Description**, and **Layer** for the first point. Also input the **Distance**, **Angle** and **Elevation** of the line from the first point.

Important



The default coordinates for the first point will be 100 (X), 100 (Y), and 10 (Z). The default distance from the first point is 10 m (32.808') and the angle is 0.00.00 degrees from plan North. If you want to designate a different origin point, see Section 4.3 Points, and create the origin point using the **Input Form** under the **Points** workslate.

5. If you created an alternate origin point, set that point as the beginning of the linework by tapping the **Input Form** again and returning to the map view and selecting the point.
6. Tap the **Create** icon.

7. To create the next line, tap the **Angle** icon to toggle between the three preset angles, 30, 45 and 90 degrees to quickly draw your plan.
8. Use the **Left** or **Right** toggle icons to move the next point and linework to the selected angle from plan North.
9. If you do not want a line created between the points, you can uncheck the box next to **Line** as you draw the plan to create only points.

10. Using the **Input Form**, you can input any **Angle**, **Distance**, **Point Name**, **Description**, **Elevation** or **Layer** for the new points and linework.
11. Tap the **Create** icon if the selected point and linework is in the correct location.
12. Tap the **Undo Arrow** to undo any point or line work creation.
13. You can always add, edit or delete points or linework in **Point Mode** or **Linework Mode** created or needed within the plan.

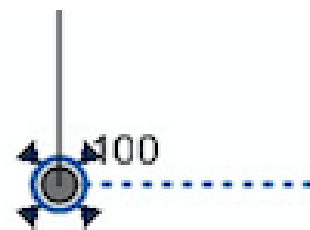
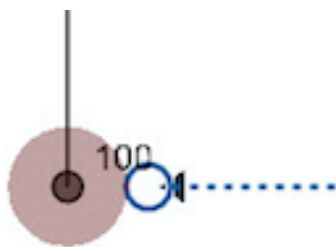
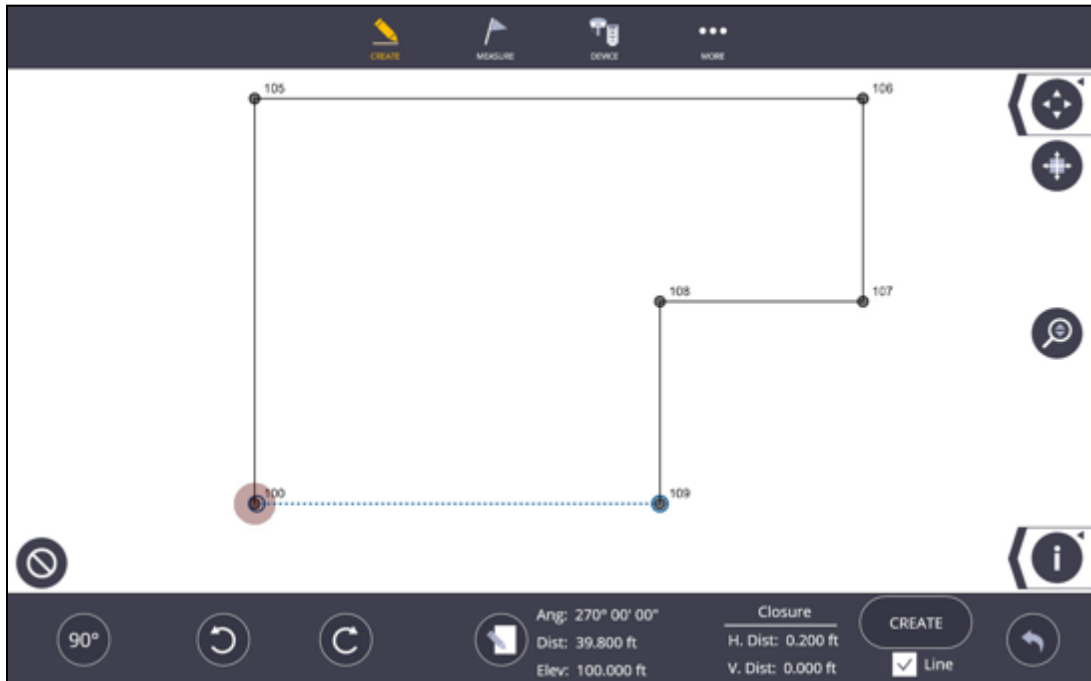

4.3 Linework

The Linework workslate allows the user to create lines or arcs between design or as-built points. You can also edit or delete collected or created linework using this tool.

1. Tap **Create**.
2. Select **Linework**.
3. Tap the **Line** icon to create a straight line.
4. Select the points to connect with Linework. You can select multiple points in sequence to draw a straight polyline through the points as selected.
5. Tap the **Create** icon.

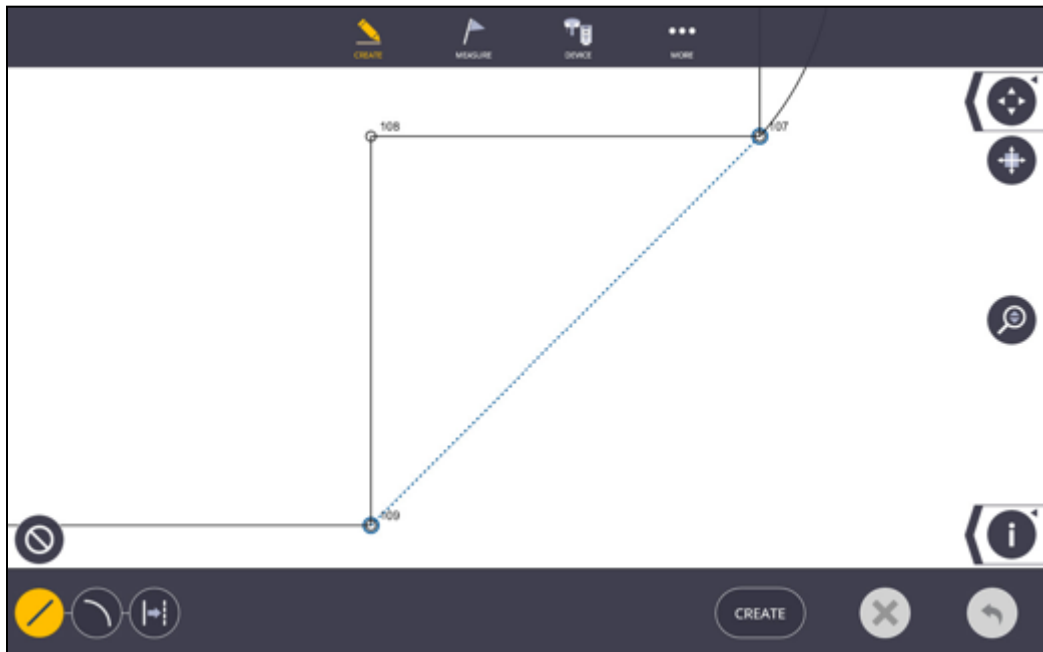

6. Tap the **Arc** icon.
7. Select two points to be linked with the **Arc**. The arc, center point and radius point will show on the screen.
8. Tap the **Input Form** icon to type in a **Radius Length**. Note the current radius is displayed next to the **Input Form** icon.
9. Tap on the **Short Arc/Long Arc** toggle icon to change the radial length.
10. Tap on the **Flip Arc** icon to change the radius point to the opposite side.
11. Tap the **Create** icon. The arc, center point and radius point will be created using the point name, description and layer as the two arc points originally selected.
12. If you need to delete a line or arc, simply tap on the linework on the screen and tap the **Delete** icon.
13. Tap the **Undo Arrow** to undo the creation or deletion of linework.

14. Tap the **Segment** icon.
15. Select the newly created or imported Line or Arc you would like to segment with points.
16. Tap the **Input Form** icon to type in the segment points **Name**, **Description**, **Layer**, and **Segment Length**. Note the current Segment Length is displayed next to the **Input Form** icon.
17. Tap on the **Flip Start** icon to change the start point for the segment points.
18. Tap the **Create** icon. The arc, center point and radius point will be created using the point name, description and layer as the two arc points originally selected.
19. Tap the **Undo Arrow** to undo the segment points.

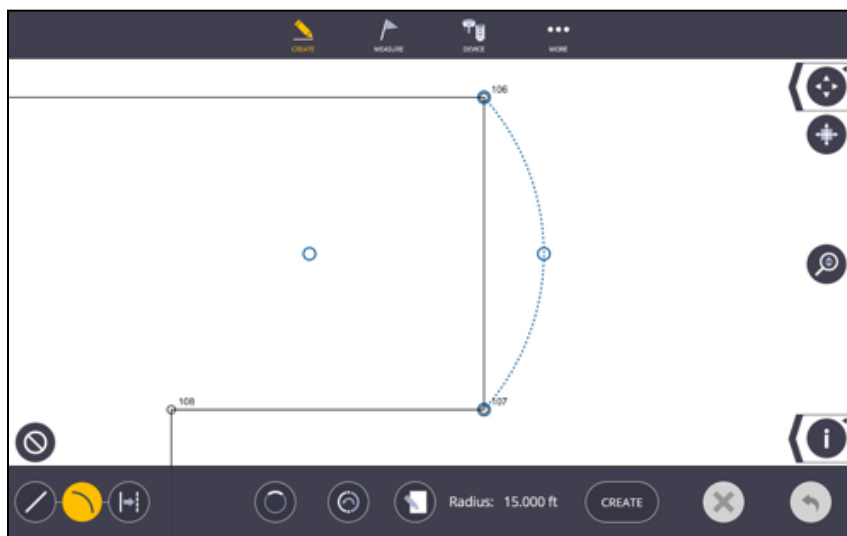

4.4 From Model

Use the Create **From Model** tool to create points from a 2D plan, 3D model or linework created in TFL, using the predefined snap options after importing the model (see Section 3.2).

Note: For FieldLink version 4.x, you can layout directly from imported or created linework simply by tapping on the linework, without creating any points on the line. This functionality may greatly reduce the need to create many points if you are staking to linework. You must still tap the stake icon to store the point for future reference, QA and documentation processes.

1. Tap the **Create** icon.
2. Select **From Model**.
3. Tap on the **Layer** icon and then tap on any of the linework you would like to isolate. The layer you select will highlight in the map view and layer list so that you can tap the **None** icon, then check next to the single or multiple layers you want to create points upon.
4. Select the required snaps by tapping in the open selection box. Current options are **End Point**, **Mid Point**, **Circle/Arc Center**, **Intersection** or **Apparent Intersections**.

Note: If using Apparent Intersections **Drag** and **Current View** options are disabled.

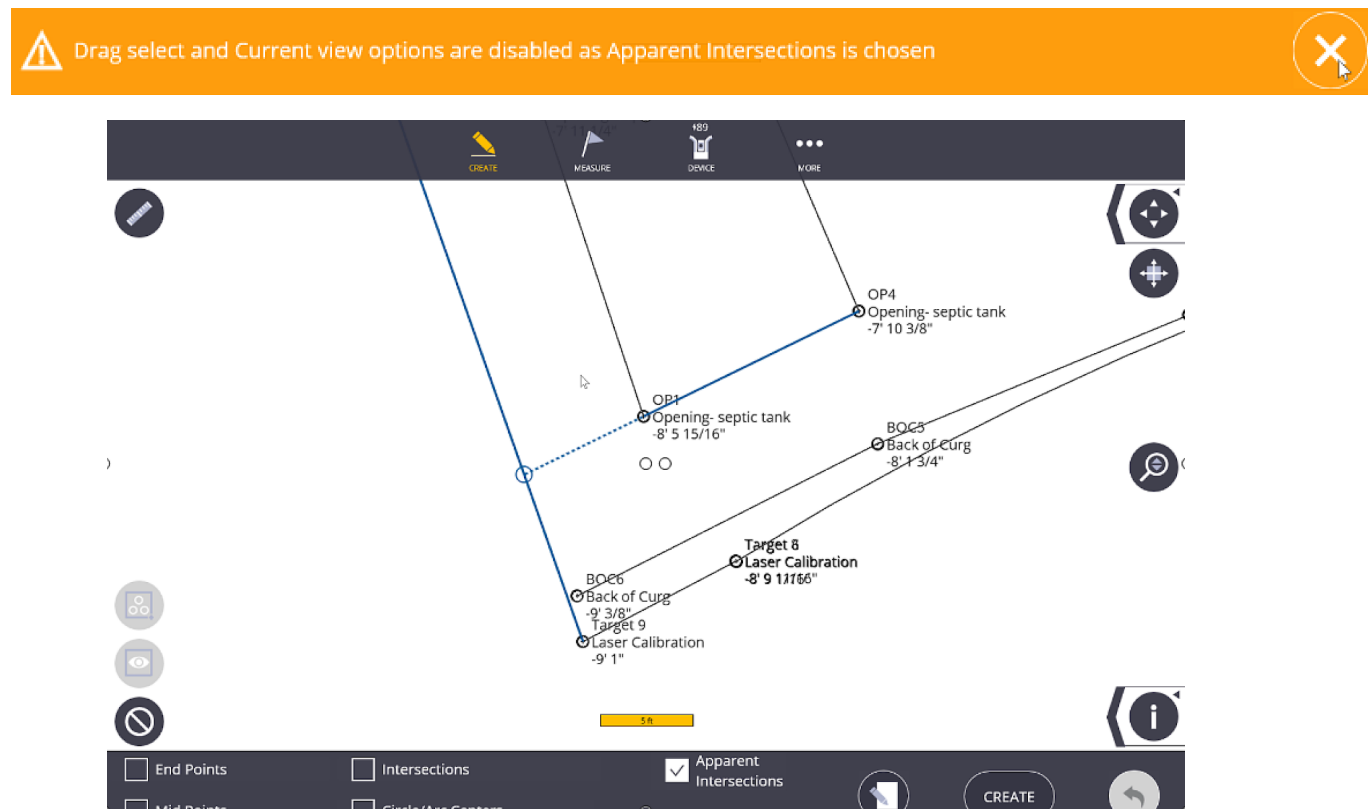

5. Tap the **Input Form** icon. Input the **Point Name**, **Description**, and **Layer** for the first point. Tap the **Input Form** icon again to view the points on the map view prior to creation.
6. Tap on each location you would like to create a point using the selected snap, or utilize the **Map Tools** icons including **Selection Box** or **Current View** tools to create multiple points quickly.
7. Tap the **Clear All** icon to clear your selected points if you made any mistakes in your selections.
8. The number of points to be created will show under the **Create** icon. Tap the **Create** icon at the bottom right of the screen to finalize the points.
9. Tap the **Undo Arrow** to undo the creation.
10. Once points are created, you can delete or edit the points within the **Points Workslate** (See Section 4.1).

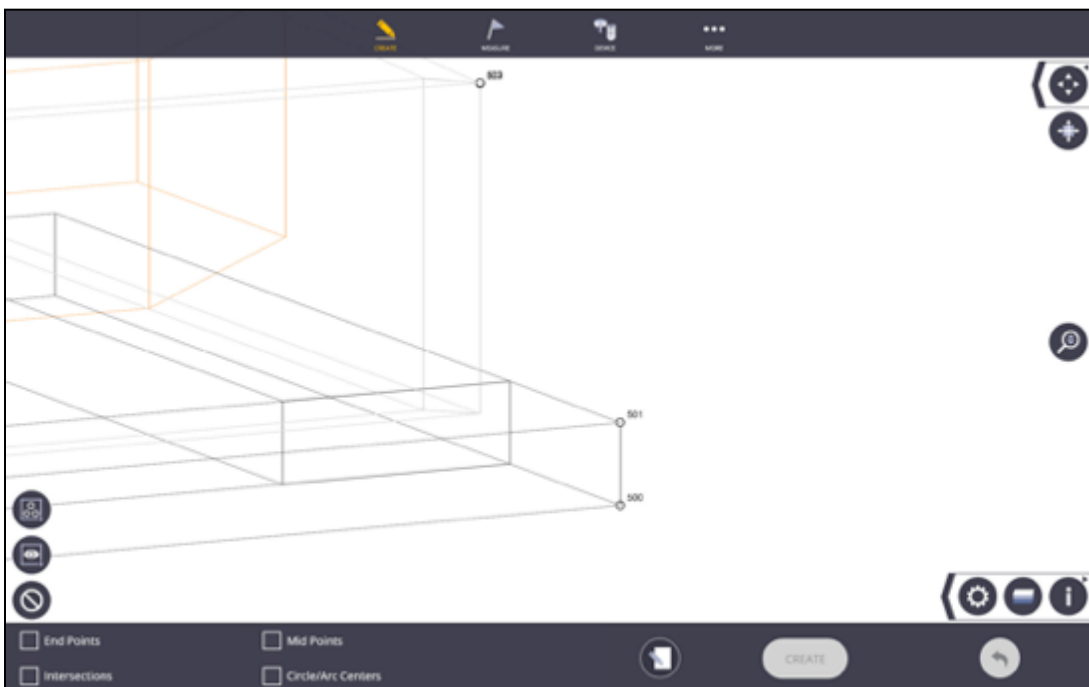

Important



If you are creating points with a 3D model, you may end up with multiple points on top of each other in a 2D view (e.g. if you are looking at a column structure from above you will create 2 points instead of one for upper and lower corners).

Tip



Use letters, numbering, descriptions and layers when creating points to help filter or sort points for easy viewing during layout, or exporting/importing field data into or from the office.

4.5 Grid

In the Create Grid work mode, the user can create points on a specified **Grid** pattern with defined point names, descriptions and layers.

1. Tap the **Create** icon.
2. Select **Grid**.
3. Tap the **Input Form** icon.
4. Input the values for each of the fields. The **Start N(X)** and **Start E(Y)** will position the first grid point at that location and defaults to 100(X), 100(Y), or select the starting point from the map view.
5. Input the **Point Name** and **Description**.
6. Input the number of grid **Columns** and **Rows**.
7. Input the **Width**, distance between the grid **Columns**, and the **Height**, distance between each grid Row.
8. Place the points on a specific layer by tapping the Layer drop-down menu, or type in a new **Layer** to create a new layer name.
9. Tap the **Input Form** icon again to view the points on the map view prior to creation if desired.
10. Tap the **Create** icon at the bottom right of the screen to finalize the grid points, or tap the **Undo Arrow** to modify the values or undo the creation.

The screenshot shows a mobile application interface for creating a grid. At the top, there are navigation icons. Below them are several input fields arranged in a grid-like pattern. The fields are: 'Start N 100.000 ft', 'Start E 100.000 ft', 'Name GD100', 'Columns 3', 'Rows 3', 'Description GRID', 'Width 5.000 ft', 'Height 5.000 ft', and 'Layer GRID'. A virtual keyboard is visible at the bottom, and a 'CREATE' button is at the bottom right. Red circles with numbers 1 through 10 are overlaid on the form to indicate the sequence of steps for creating the grid.

11. Use the **Map Controls** icons including the **Zoom Extents**, **Zoom Slider Bar**, **Point Information**, **Map Settings** and **Layer** icons to isolate an area or layer for viewing, or to show the point layer, description, and elevation information.

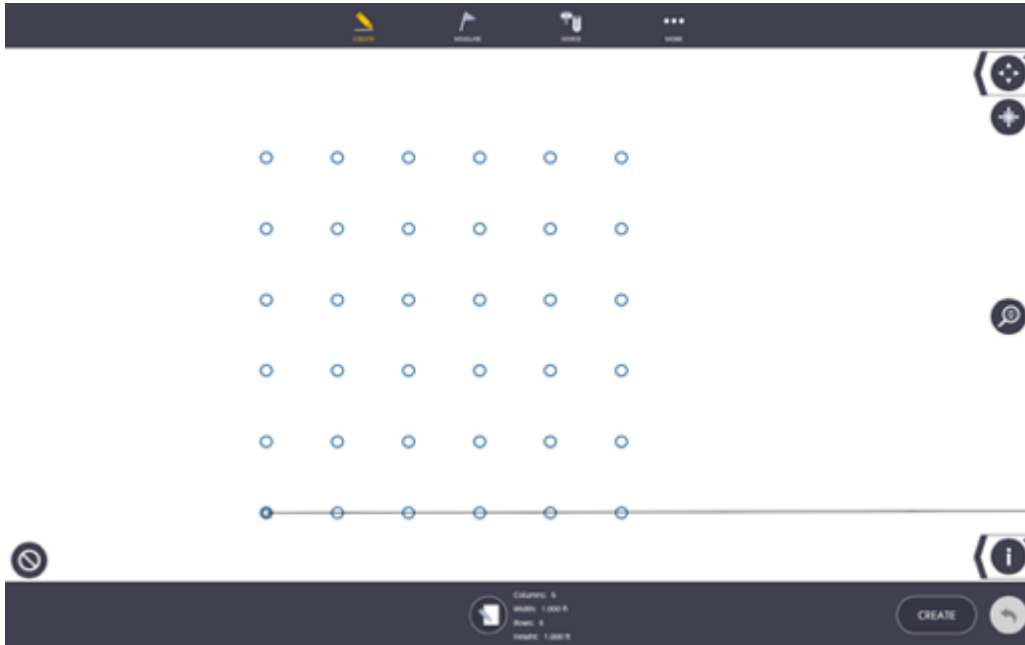

4.6 Pattern

Point Patterns help with the creation of points that repeat numerous times and can be centered around another point such as anchor bolts, offsets, hangers,... . You can also share these point patterns with other FieldLink users.

1. Tap the **Create** and **Pattern**

For a **New Pattern**

2. Tap the **Input** form and **Enter** the X, Y values.
3. You can also enter the grid spacing to be able to select background grid intersections directly on the screen.
4. To view the location of the point on the map screen, tap the input form again.
5. Tap directly on the grid intersections to temporarily create additional points.
6. Tap **Add Point(s)**. Repeat to add more points to the pattern
7. To save the pattern, Tap **Save Pattern, Enter Name** and press **Save Pattern**.

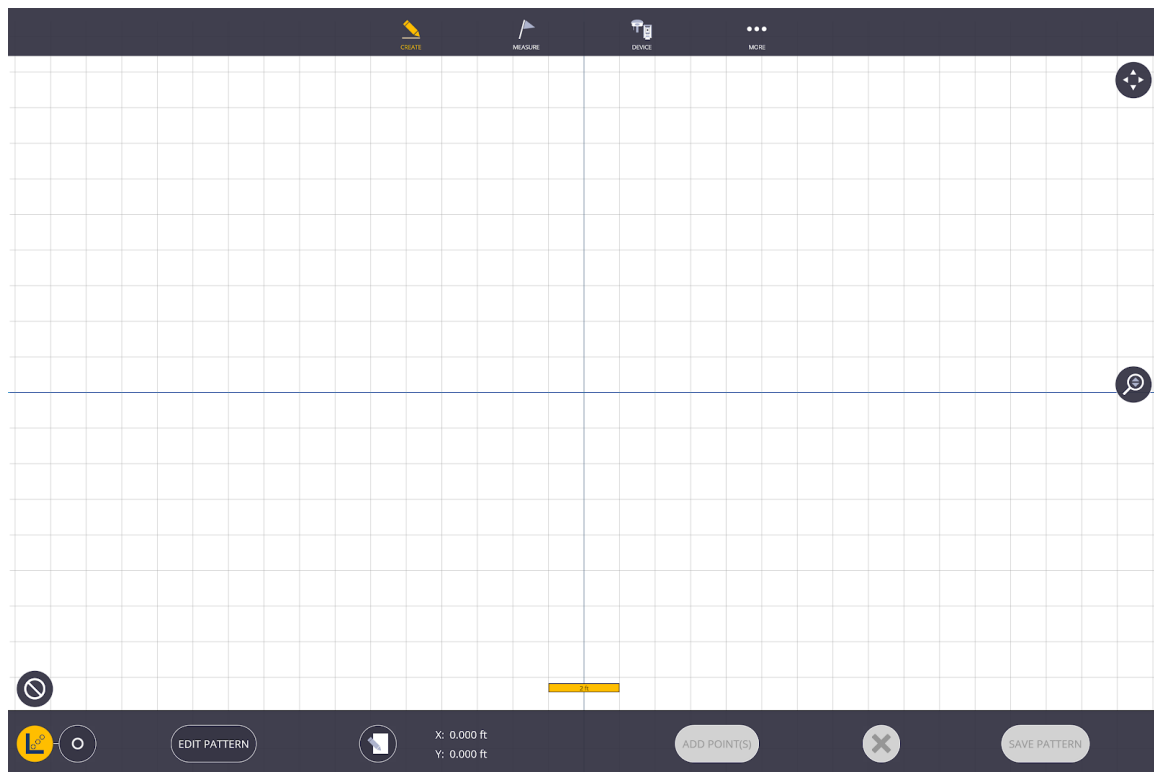

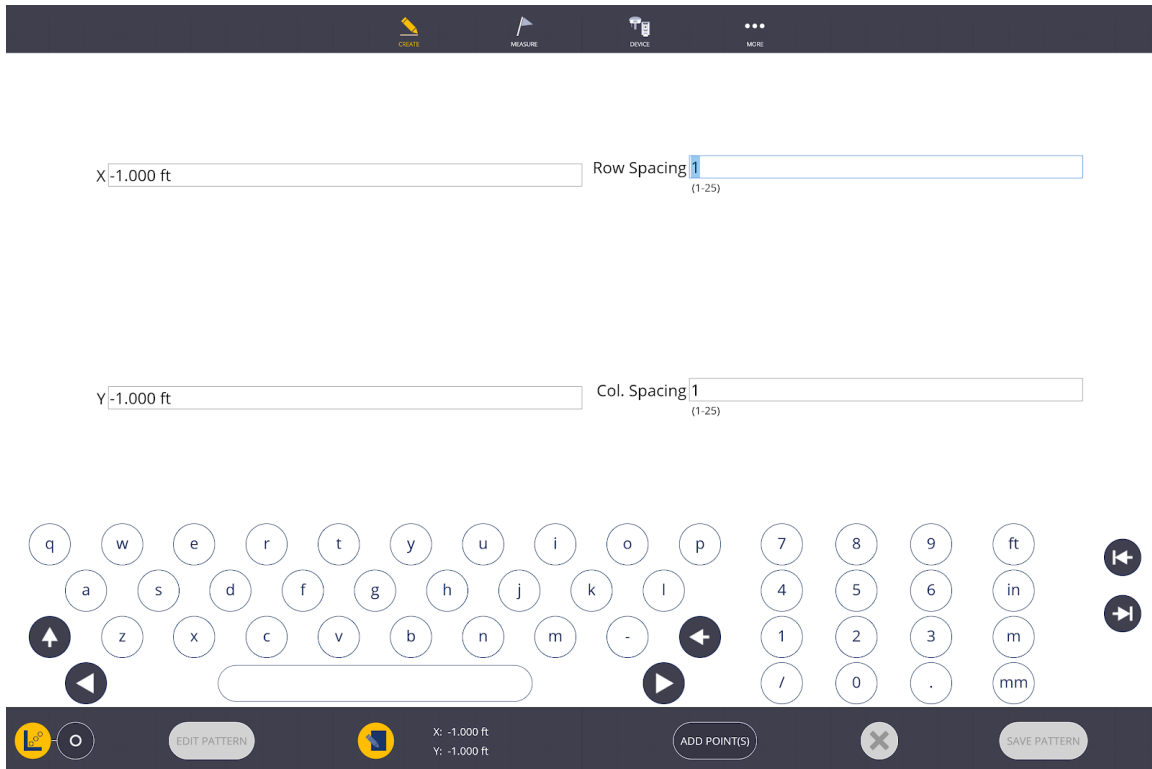

For an **Existing Pattern**

1. Tap **Edit Pattern**. You may have to tap **Clear Pattern** if you don't see the pattern you wish to edit.
2. Select the pattern from the file location. Tap **Load Pattern**
3. To edit the pattern. Tap a **point** in the pattern and tap the **Input Form** to change the X, Y values. Tap **Save Point**
4. Tap **Save Pattern**

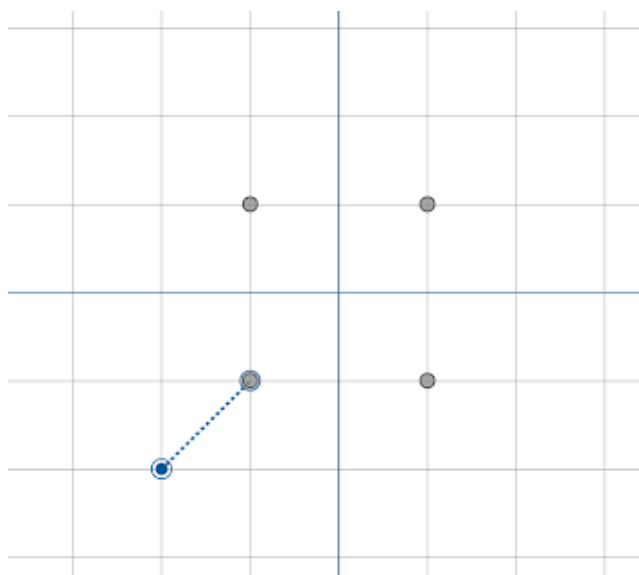

To Place the Pattern

5. Select the **Point** icon.
6. Tap **Select Pattern**, select the pattern from the file list and tap **Load Pattern**.
7. Select the center **Point or Points** on the map screen where you want the pattern to be created
8. To **Rotate** the pattern, select from the **Preset Angles** or tap the **Input Form** to type in a specific angle. Also, you can enter the starting point name, description and select/enter the model layer.
9. Tap **Create**.

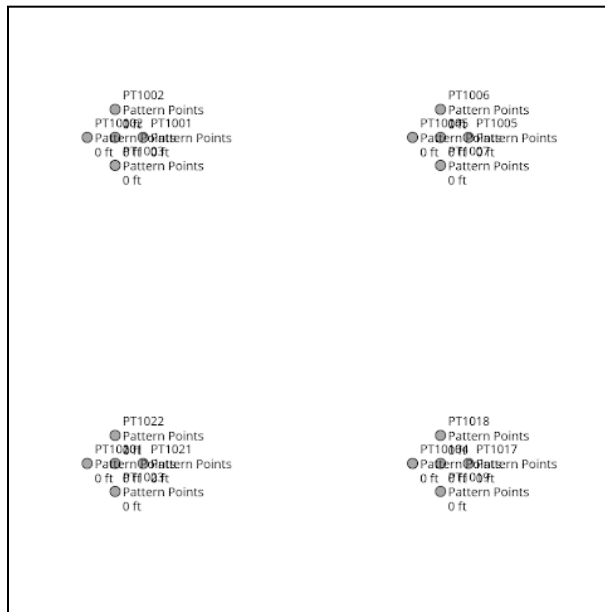
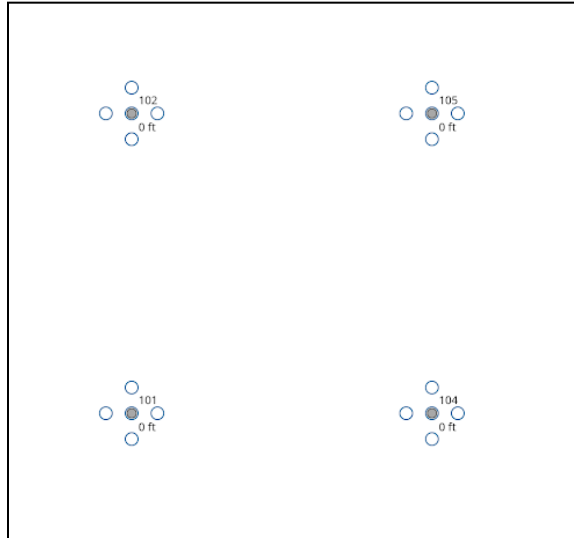

5. Device Mode

Before we collect or lay out data, we must first connect a Robotic Total Station, Rapid Positioning Tool or GNSS Receiver, make sure our prism and instrument settings are correct, and then set up the instrument for its position on the project. The instrument and prism tasks are all accomplished in the Device Mode.

5.1 Connection

5.1.1 Robotic Total Stations (RTS)

In order to connect to the instrument, make sure the RTS is turned on with a fully charged battery.

1. Tap the **Device** icon.
2. The connection window will automatically open. Make sure to select the RTS icon from the row of instrument types.
3. Place the battery into the RTS with the battery indicator down and the charging ports facing the inside of the RTS.
4. Press the power button on the RTS.
5. **Enter** the **Channel** and **Network ID** that matches those in the face 2 display on the RTS.
6. Tap **Connect**
7. Once completed with the layout or collection process, tap the **Disconnect** icon in the Connection window before turning off the RTS. Tapping the **Disconnect** icon will help ensure a proper shutdown and later reconnection.

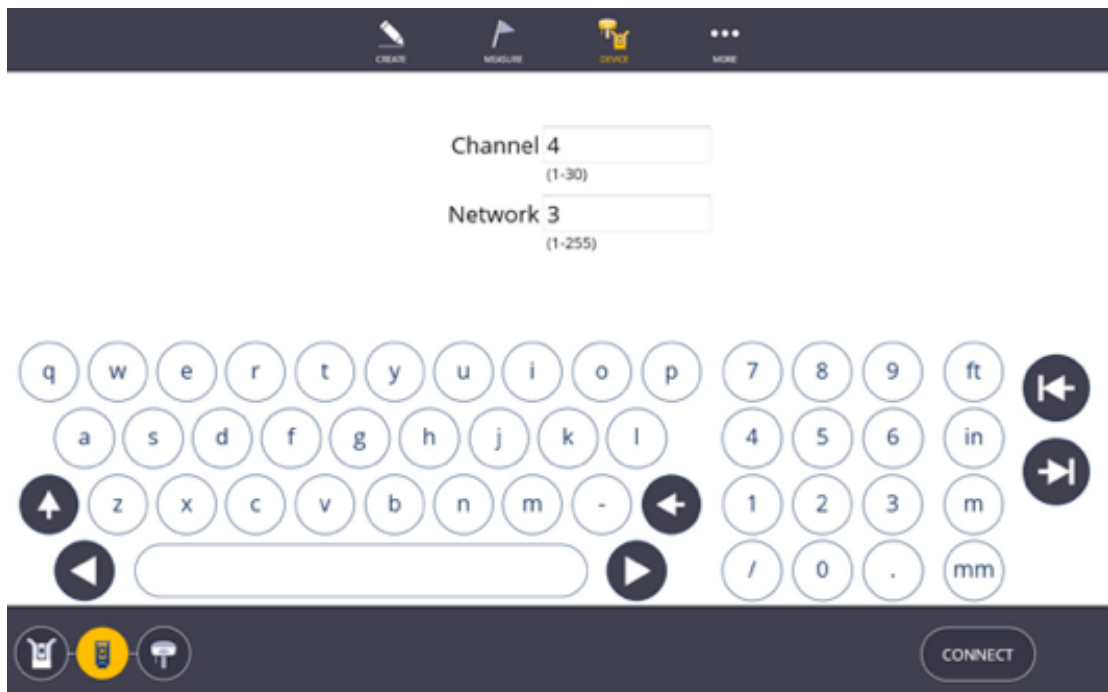

5.1.2 Trimble TDL2.4 Data Link Radio



NOTE: When connecting to an RTS using a **Trimble Data Link Radio**, the radio must be paired before first use.

PAIRING INSTRUCTIONS

While in the CONNECTION window, after setting the correct Channel and ID, press and hold the "radio" button on the Trimble Data Link radio before pressing the CONNECT button in the CONNECTION window.

Once the Trimble Data Link Radio is successfully paired, the radio's Bluetooth name will be displayed in the FieldLink workslate.



Press the "radio" button on the Trimble Data Link Radio for 2 seconds to enable discovery mode before pressing CONNECT



Radio: RB 001020

FORGET RADIO

DISCONNECT

5.1.3 Rapid Positioning System (RPS)

In order to connect to the instrument, make sure the RPT is turned on with a fully charged battery.

1. Tap the **Device** icon.
2. The connection window will automatically open. Make sure to select the RPT icon from the row of instrument types.
3. Place the battery into the RPT with the battery indicator up and the charging ports facing the inside of the RPT.
4. Press the power button on the RPT.
5. Select the correct RPT serial number from the list of available instruments or press the **Find** button if your device is not shown.
6. Tap **Connect**

Once completed with the layout or collection process, tap the **Disconnect** icon in the Connection window before turning off the RPT. Tapping the **Disconnect** icon will help ensure a proper shutdown and later reconnection.

Screen Shots



Tip

Make sure your tablet is disconnected from other WiFi sources to ensure a clear connection to the instrument.

5.1.4 Trimble Ri

Upon powering on the instrument, the Ri automatically performs a tilt detection and a field calibration. The instrument will rotate horizontally during tilt calibration. It is important to know that the instrument even if not physically leveled. Instead the instrument calculates the tilt plane and during measurements a correction will be applied based on the amount of tilt.

During field calibration, it will move side-to-side and up and down. Field calibration focuses the mirrors, calibrates the instrument to infinity, and adjusts the instrument to environmental conditions. Thanks to the self-calibration of the instrument, it does not have to be sent in for service annually like other total stations need to.

Avoid touching the instrument during its calibration process. The Ri is gear-driven and interfering with its movements is not advised.

The full autostart process takes around three minutes. After the instrument is calibrated to its environment, it can connect to a data controller. A connection cannot be made while the instrument is still in calibration mode. Note that level detection and tilt compensation is performed during the calibration and connection stage, so there is no need to auto-level again.

Once the instrument has performed the calibration, you can select the Vibration Sensitivity to be High, Low, or Off. Vibration sensitivity does not actually detect

vibrations, rather it measures changes in its surroundings. High considers all environmental factors, and low considers all except for changes in temperature and timeout. Setting it to Off is only appropriate for demonstrations in extreme conditions such as set up on a meeting room table as this ignores all environmental factors, except for the instrument being off level by more than 5 degrees.

To connect to the Ri:

1. Select the correct Ri serial number from the list of available instruments or press the **Find** button if your device is not shown.
2. Tap **Connect**
3. Once completed with the layout or collection process, tap the **Disconnect** icon in the Connection window before turning off the Ri. Tapping the **Disconnect** icon will help ensure a proper shutdown and later reconnection.

To change the WiFi Band:

1. Select **Device/Settings**
2. Click on the Wi-Fi Band arrow
3. Select **Band** Automatic or Automatic24GHzOnly or Automatic5GHzOnly
4. **Reboot** of **Ri** is required for the new Band to be in effect

5.1.5 Global Navigation Satellite System (GNSS)

1. Tap the Device icon.
2. The connection window will automatically open. Make sure to select the GNSS icon from the row of instrument types.
3. Place the battery into the GNSS receiver with the charging ports facing the inside of the GNSS receiver mating charging ports.
4. Press the power button on the GNSS.
5. Enter the Channel and Network ID that matches those in the face 2 display on the RTS.
6. Tap Connect
7. Once completed with the layout or collection process, tap the Disconnect icon in the Connection window before turning off the RPT. Tapping the Disconnect icon will help ensure a proper shutdown and later reconnection.

US-2013 - 12.5KHz		
TrimMark3		
LINK RATE (bps)	9600	
TrimTalk450S		
LINK RATE (bps)	4800, 8000	
Satel		
Forward Error Correction (FEC)	ON	OFF
Scrambling	ON	OFF
LINK RATE (bps)	9600	
TransparentFST		

Forward Error Correction (FEC)	ON	OFF
Scrambling	ON	OFF
LINK RATE (bps)	9600	
Transparent		
Forward Error Correction (FEC)	ON	OFF
Scrambling	ON	OFF
LINK RATE (bps)	4800	

US-2013 - 25.0KHz		
TrimMark3		
LINK RATE (bps)	9600*, 19200	
TrimTalk450S		
LINK RATE (bps)	4800*, 8000*	
Satel		
Forward Error Correction (FEC)	ON	OFF
Scrambling	ON	OFF
LINK RATE (bps)	9600*, 19200	
TransparentFST		
Forward Error Correction (FEC)	ON	OFF
Scrambling	ON	OFF
LINK RATE (bps)	9600*, 19200	
Transparent		
Forward Error Correction (FEC)	ON	OFF
Scrambling	ON	OFF
LINK RATE (bps)	4800*	

* Link rates marked with an asterisk (*) indicate a wireless mode that is illegal within the US as of January 1, 2013 (<https://www.fcc.gov/narrowbanding-overview>)

5.2 Prism Settings

In order to take correct measurements, you must first select the correct prism type, prism height, and rotate the RTS to the correct measurement point. To do this you must be connected to an instrument.



5.2.1 Prism Quick Access

The Prism Quick Access button allows you to access the prism quickly from the main Map screen.

1. Tap the Prism Quick Access button.
2. Select the desired target type from the **Target Type** selection list. Options include the 360 Prism, MT1000, AT360, Reflective Foil (*will automatically turn off Auto Lock*) or Custom Prism.

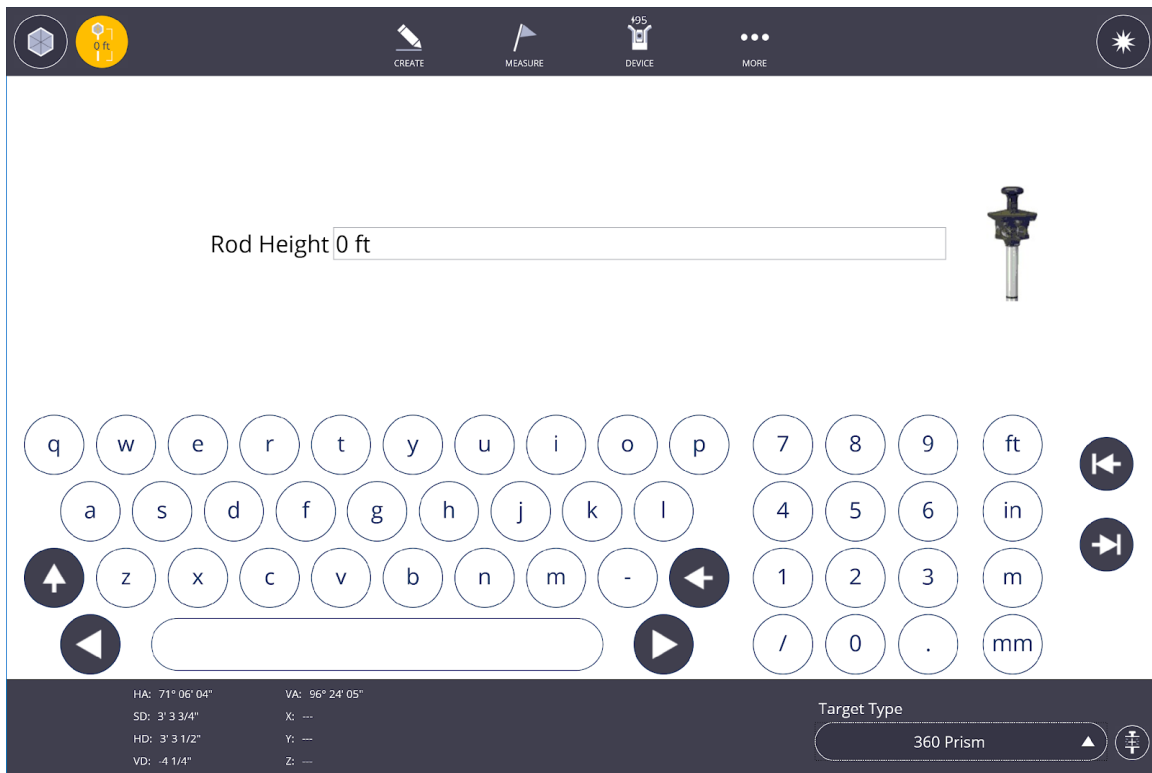

- a. Custom Prism button allows you to add, name, configure and save commonly used prisms on your job site.
- b. Press the Custom Prism Button and populate the fields including Prism Name, Prism Constant, and check the box if the Prism is wider than 30

mm (1-3/16"). 

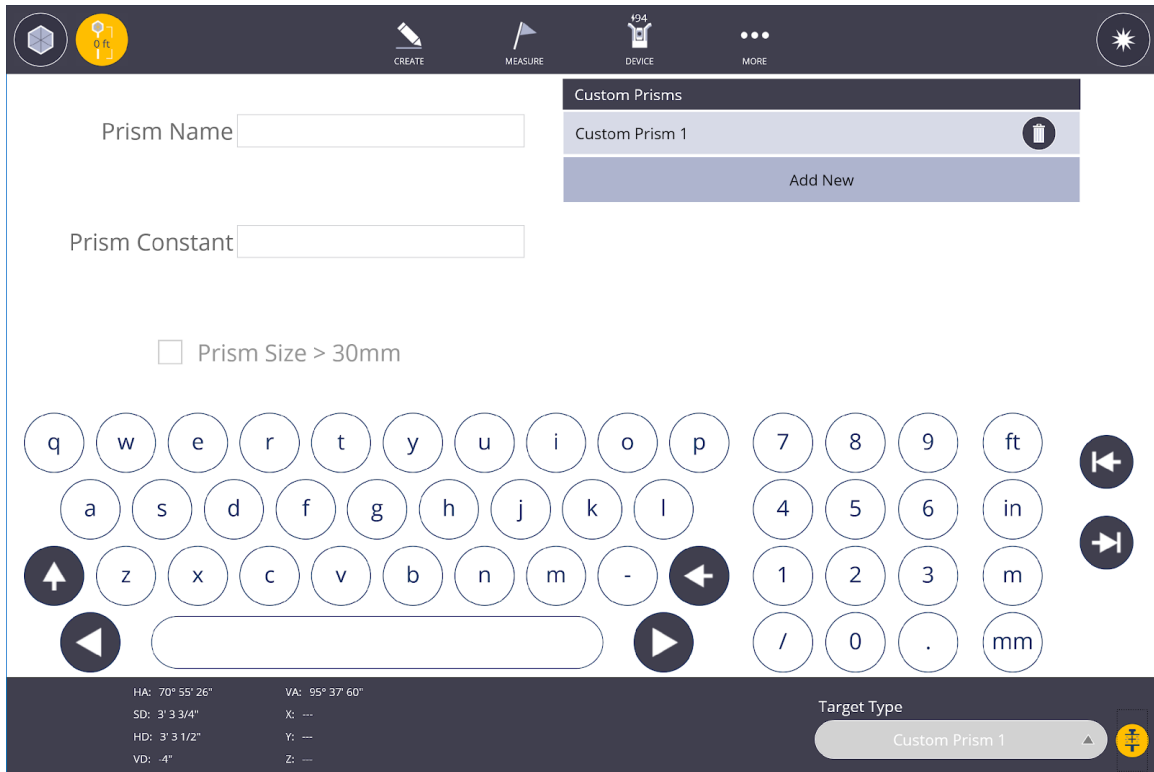

3. Type in the correct Height of Rod (HR). Measure to the center of the prism to the tip of the rod for the 360, MT1000 and AT360 prisms. If you have an Inverted Layout Rod you can utilize the value displayed on preset positions.

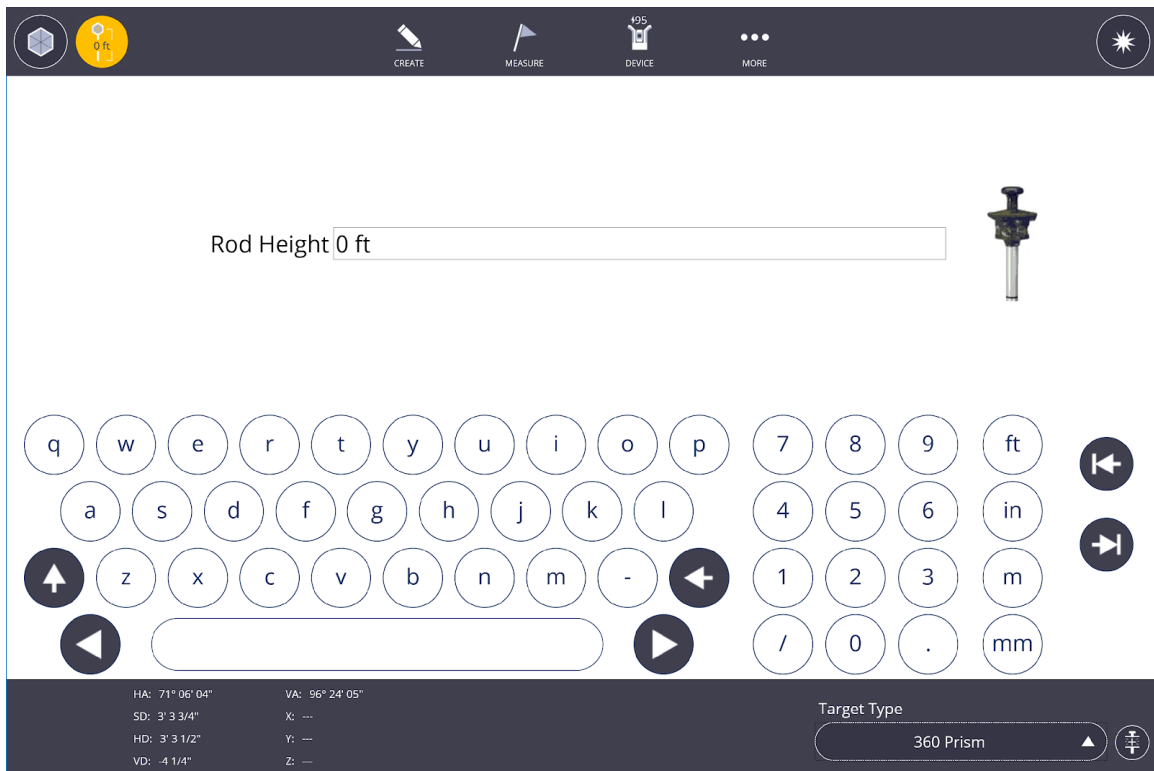

4. If you want to shoot the control points utilizing the EDM laser beam (also known as Laser mode), tap the **Prism** icon in the upper left to toggle between Prism and Laser mode.
5. Tap the **Vision** icon to turn on the live video camera within the RTS. In Trimble Vision mode, you can tap on the video image to rotate the RTS to a specific point or use the Joystick icons as well. There are zoom controls on the right side of the screen to zoom the video feed in or out.
6. Slide out the () and tap the **Joystick** icon to activate the horizontal (left hand side) and vertical (right hand side) movement bars. Tap the **Joystick** icon again to close the tool.
7. Tap on the **Search** icon to lock onto a prism. The search mode will close Vision mode and open the plan view in order to lock onto the prism. The Prism icon will appear to be rotating if the RTS is not locked onto a prism, or solid once locked onto the prism.
8. While locked onto a prism or aiming in laser mode, this screen will give you the HA (Horizontal Angle), VA (Vertical Angle), SD (Slope Distance), HD (Horizontal Distance), VD (Vertical Distance), X, Y and Z coordinates.

5.2.1 Tap to Search

If you are not locked onto your prism, the Prism icon in the upper left corner will appear to be rotating and not a solid icon. A Question Mark icon will appear in the upper left corner next to the Prism icon which you can press to start a localized search in an 11 degree tall by 15 degrees wide window for RTS series, 25 degrees tall and wide for the RPT.

1. If the prism is not locked, a line will appear where the instrument is pointed.
2. Tap on the screen roughly on the location of your prism. The instrument should automatically point to the tapped location and start the search process for the selected prism.
3. If the prism is not found automatically, press in another location on the plan view or utilize Trimble Vision to isolate your search area.

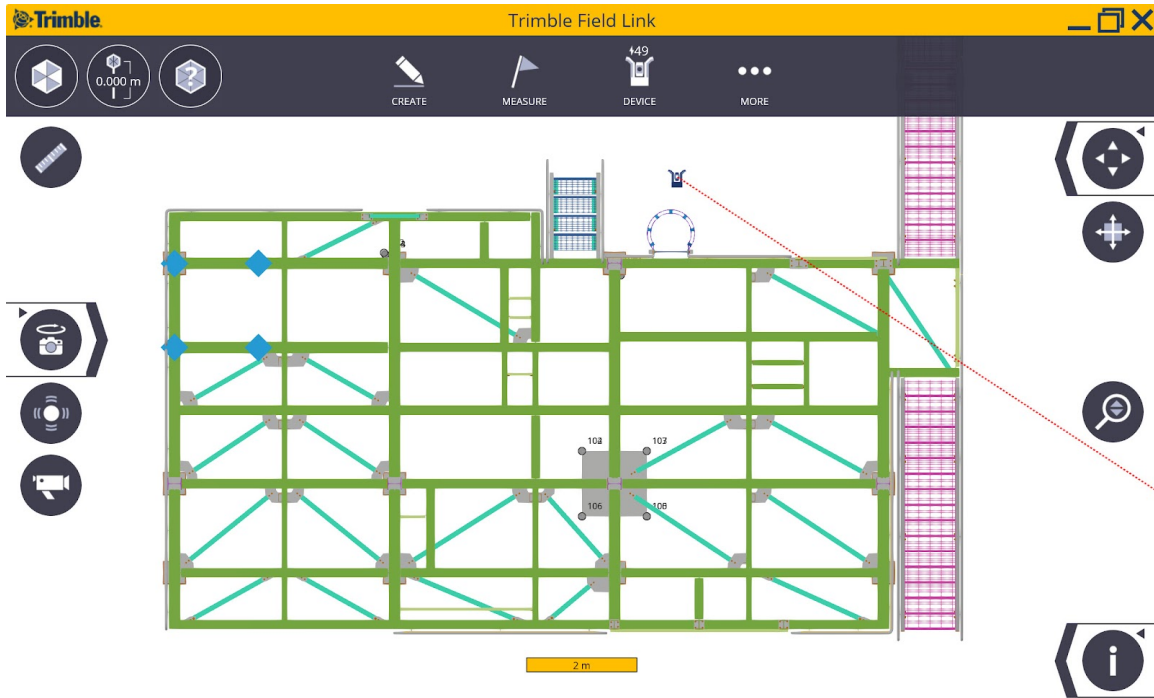
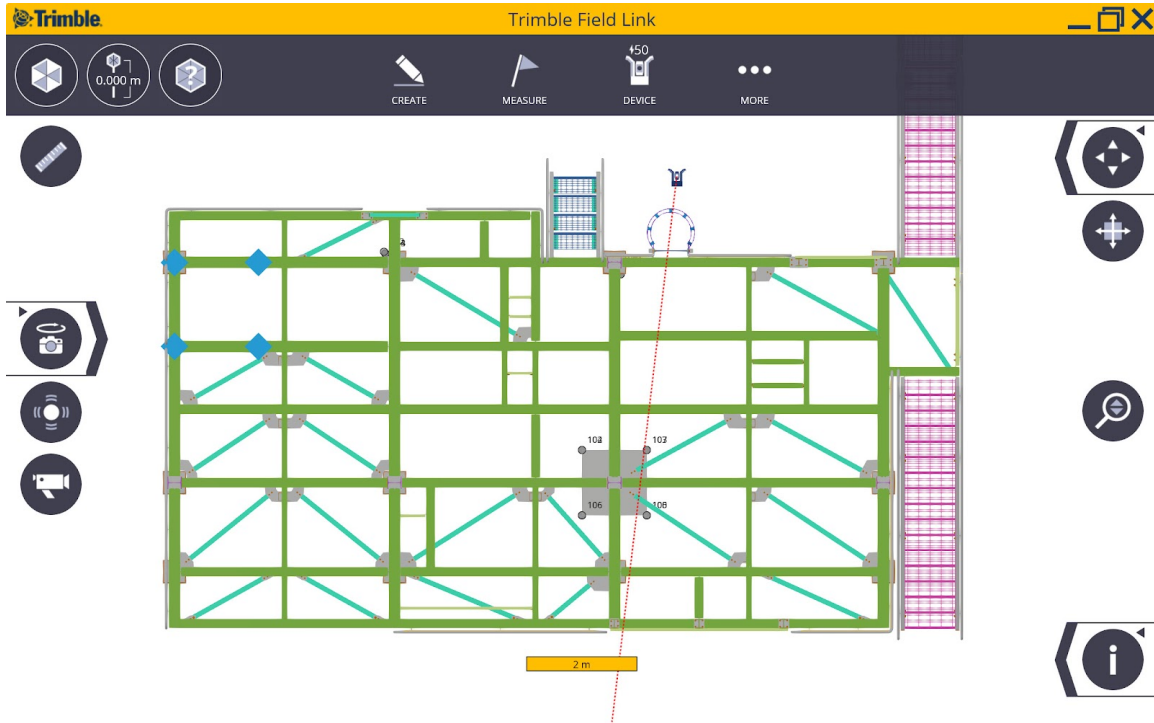



5.2.2 Pano-Search

By clicking on a Panoramic Image generated by the field instrument you can quickly lock onto the prism at your location thus eliminating lengthy aiming of the instrument. The Pano-image can also be used for quick aiming in Laser measurement mode.

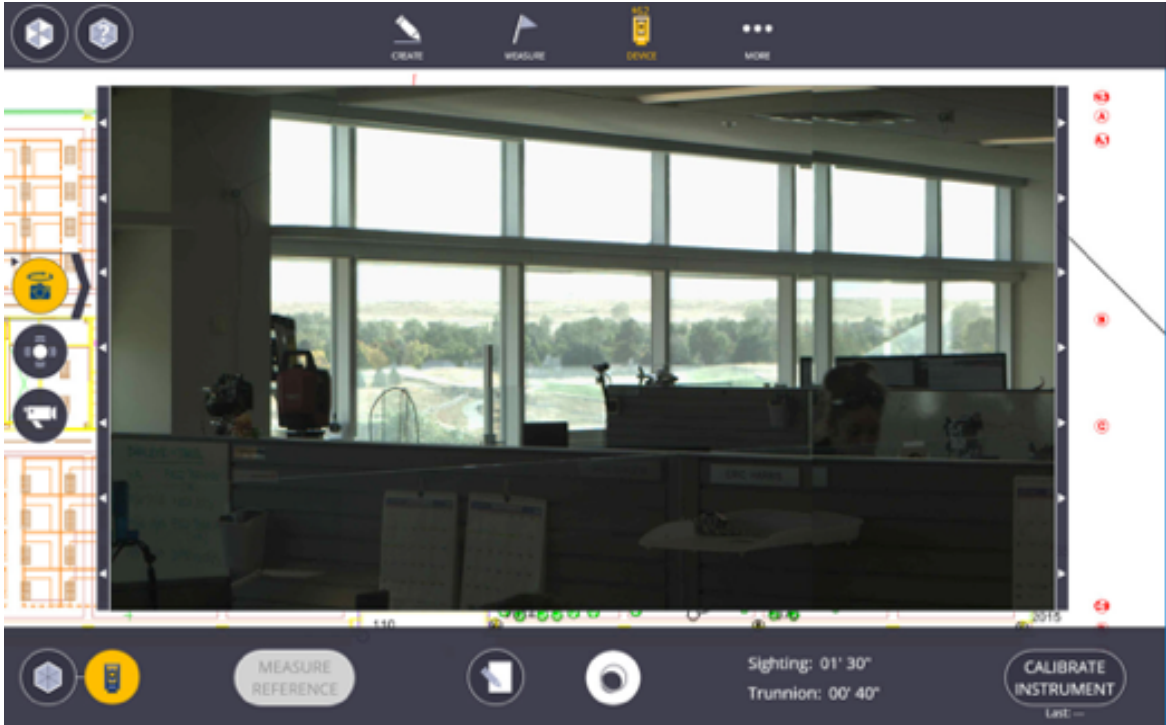

1. Tap **Pano** icon to collect panorama image (2-10 minutes)
2. If a panorama already exists on the tablet, you will be given the option to use the stored one or take a new one. Only use the stored one if the instrument has not been moved
3. Pan image, then **tap/double tap** on image that you see **behind RTS** to initiate the search for a prism. (Single tap for Windows 10 tablet or double tap for Windows 7 tablet)
4. In **Laser mode**, tap on the image to aim to location



5.3 Trimble Ri Vision and Joystick Controls

When using the Trimble Ri you will experience different icons and controls. The table below provides an understanding of the new icons/controls and how they work

Icon	Description	Function
	Maximum Zoom level	Prism Mode: targets may auto-lock if in view. Laser Mode: precise aiming to natural target or feature
	Detail Zoom level	Prism Mode: targets may auto-lock if in view Laser Mode: improved aiming to natural target or feature
	Overview Zoom level	Prism Mode: initial aiming, targets will not lock automatically Laser Mode: initial aiming to natural target or feature

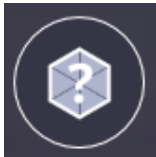
 	<p>Prism Mode: SearchLock</p> <p>Laser Mode: Laser AutoFocus</p>	<p>Prism Mode: this button appears in the VISION and joystick screens. Pressing this button will cause the instrument to cycle through lens positions in an attempt to lock onto a target</p> <p>Laser Mode: The button appears in the VISION and joystick screens. Pressing this will attempt to focus the laser and sharpen the video image. It will only succeed if using an adequate reflective surface.</p>
	<p>Target Search <i>(Horizontal)</i></p>	<p>This will perform a side to side search for targets. It will not adjust the focus distance of the lenses. For that, use the "SearchLock" button described above.</p>

5.4 Device Settings

Prior to taking any measurements, ensure the RTS is calculating the correct Reference Elevation, Temperature, Pressure.

1. Tap the **Device** icon.
2. Select **Settings**.
3. FieldLink will automatically open the prism settings mode.
4. Tap the **Device** icon to modify the instrument settings and access other functions.
5. Tap the **Input Form** icon to type in the *Reference Elevation, Temperature, Pressure*
6. The **Temperature** should be input within 10 degrees Fahrenheit (5 degrees Celsius) to ensure the accuracy of the electronic distance measurement.
7. The **Pressure** should be input utilizing local weather reporting to ensure the accuracy of the electronic distance measurement. The standard atmosphere is 29.92 inHg for imperial or 760 mmHg for metric, but the barometric pressure will vary depending on weather conditions and altitude.

To change the WiFi Band with the Ri:

5. Select **Device/Settings**
6. Click on the Wi-Fi Band arrow
7. Select **Band** Automatic or Automatic24GHzOnly or Automatic5GHzOnly
8. **Reboot** of **Ri** is required for the new Band to be in effect

5.5 Measure Reference Elevation

Use this feature to match the elevations in the layout file to the job site. For example, if your model has all points at elevation of zero, you can shoot to the floor or ceiling where you want to layout and give it a reference elevation of zero.

1. Tap **Device** and then **Reference Elevation**
2. Tap **Input Form** to enter reference elevation
3. Point instrument at the surface you wish to assign reference elevation
4. Tap **Measure**
5. A message will appear to let you know the reference elevation has been measured.
6. You also have options to **Clear** or **Re-measure** the reference elevation

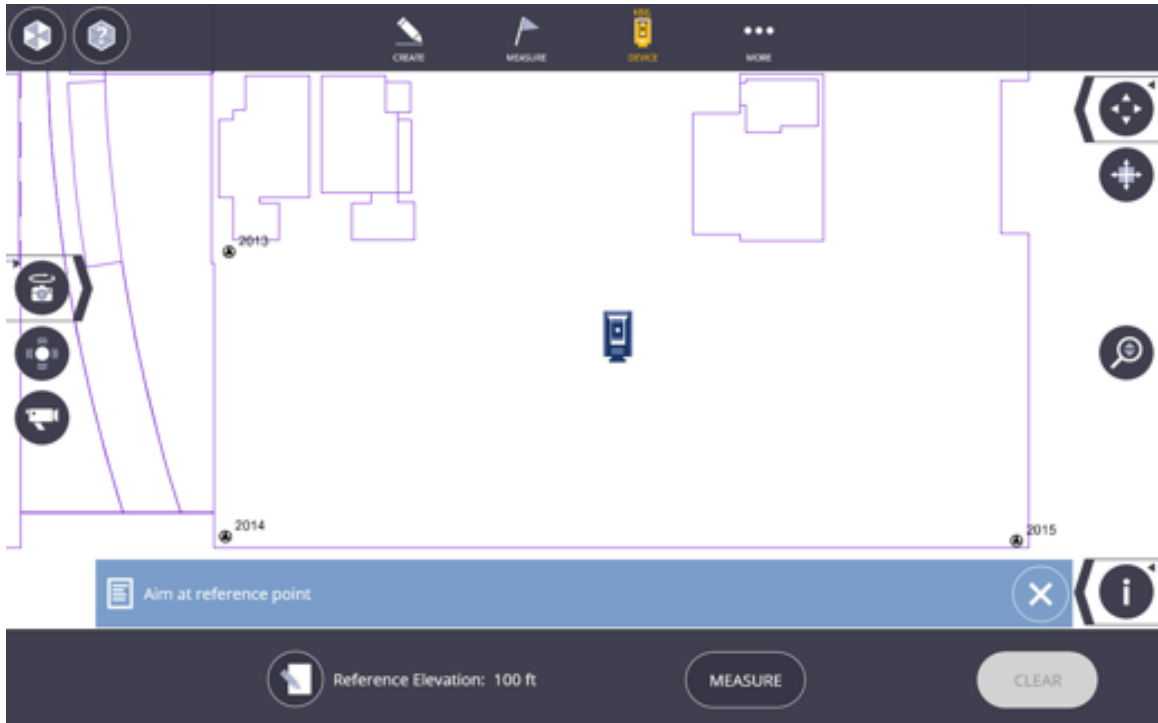

5.6 Turn To (Theodolite type option)

Use this feature to set the instrument angle to specific degrees/minutes/seconds, turn the instrument by a set horizontal angle, or basic distance and angle measurements.

1. Tap **Device** and then **Turn To**
2. **Aim** the instrument towards your reference and tap **Zero HA**
3. Tap **Input Form** to enter a **custom angle** or use the **preset angles** of 90, 45 or 30 degrees.
4. Tap the **Rotate** buttons to turn the instrument
5. **Measurement information** is displayed to the new location such as Horizontal Angle, Vertical Angle, Slope Distance, Horizontal Distance, Vertical Distance and Coordinate values.

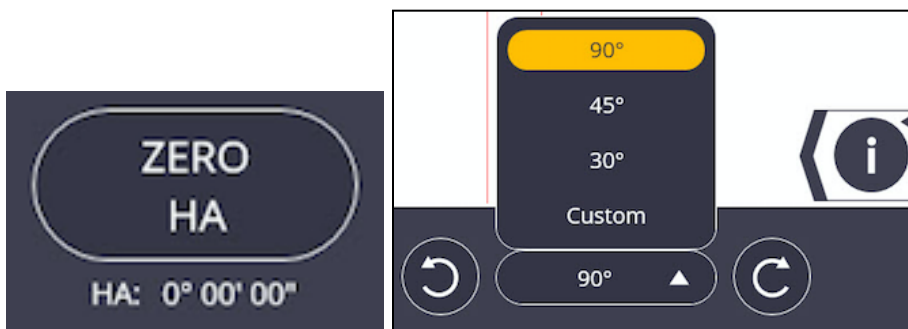

HA: 0° 00' 00"	VA: 90° 07' 05"
SD: 30.304 ft	N: -56' 10 1/8"
HD: 30.304 ft	E: 12' 1 13/16"
VD: -0.062 ft	Z: 133' 3 11/16"

5.7 Tools

The Tools function has been added to quickly access measurement options using the instrument. These tools can be used without completing an instrument set up or having any project information. Simply connect to your instrument and then begin taking measurements.

5.7.1 Quick Vertical Alignment Check Tool

1. Tap the **Device** icon and then **Tools** menu.
2. Select if you are working on a **Column** or **Wall**. You will see a message below giving instructions on how to aim the instrument. Columns require one single point shot at the base and the user should be as perpendicular to the column. Walls require two points shot along the base to give an angle of reference.
3. Use the Horizontal/Vertical tools, the Bump Tools along the right hand side of the screen to get the laser pointed to exactly the correct location(s), or simply press on the center of the screen to move the laser directly.
4. Tap the **Measure** icon at the upper right corner, one location at the base of the column, or two locations along the base of a wall.
5. Set the **Tolerance** distance at the base of the screen to your desired accuracy.
6. Aim the instrument at the top of the column or wall.
7. The screen will show the direction the column or wall should be placed for plumb and will go Green once the item is within tolerance.

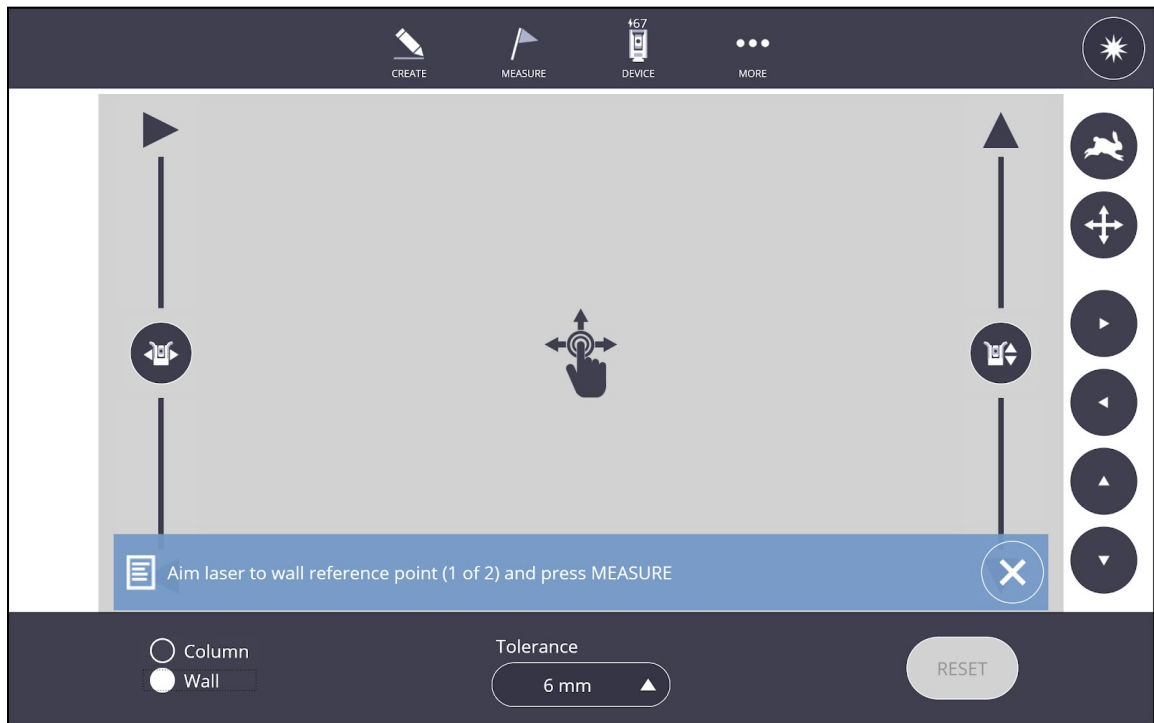
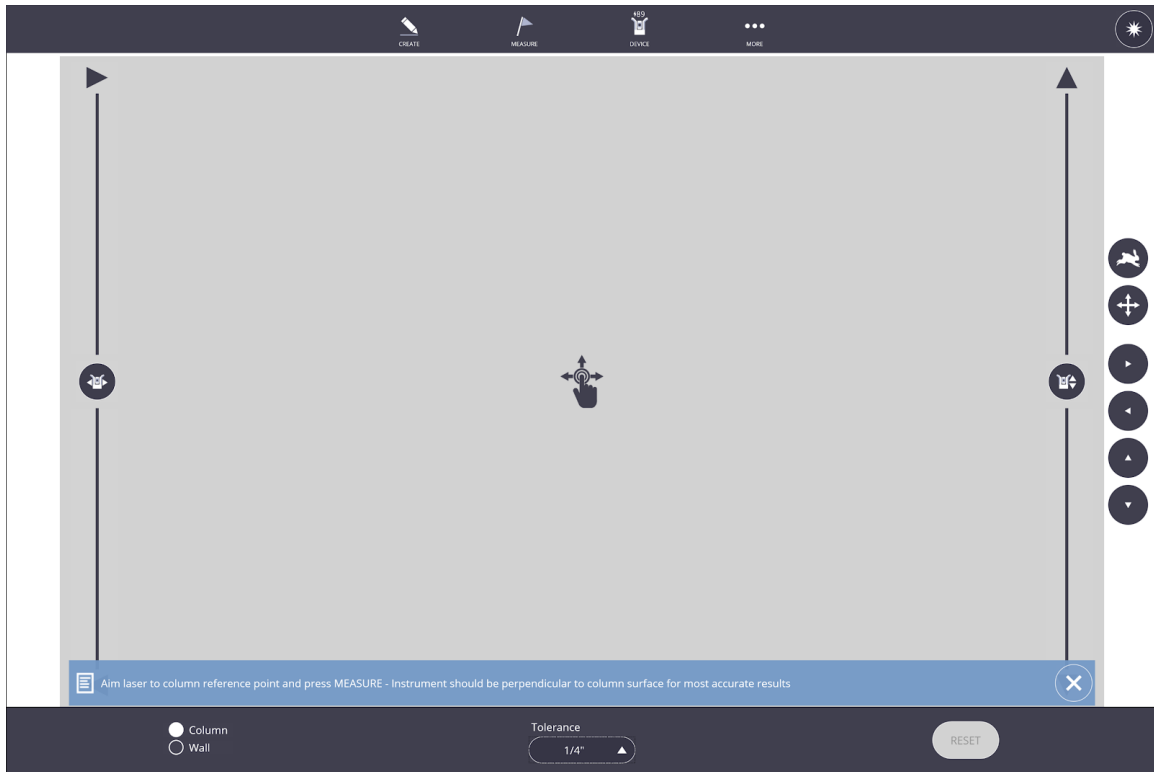

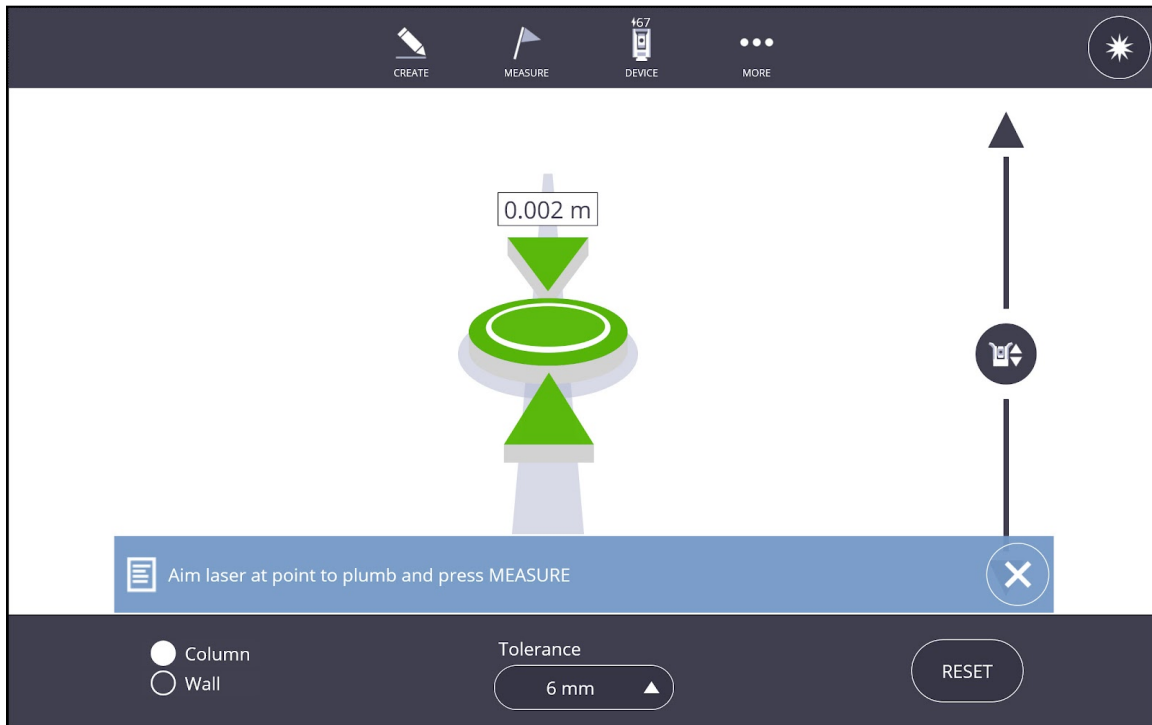

5.7.2 Tape Measure Tool

1. Tap the **Device** icon and then **Tools** menu.
2. Select the **Tape Measure** icon.
3. Tap the **Measure** icon at the upper right corner when the prism is over the first point or aiming with the laser.
4. Tap the **Measure** icon at the upper right corner when the prism is over the second point or aiming with the laser.
5. The Horizontal Distance, Vertical Distance and Slope Distance will automatically be displayed after the second shot.
6. If you have a station set up, the distances will also be given in an XYZ or NEZ format.



5.7.3 Benchmark Transfer Tool

1. Tap the **Device** icon and then **Tools** menu.
2. Select the **Bullseye** icon.
3. Tap the **Measure** icon at the upper right corner when the prism is over the benchmark point or aiming with the laser.
4. This position will be represented by a vertical tolerance bar displaying the collected benchmark position at 0' elevation.

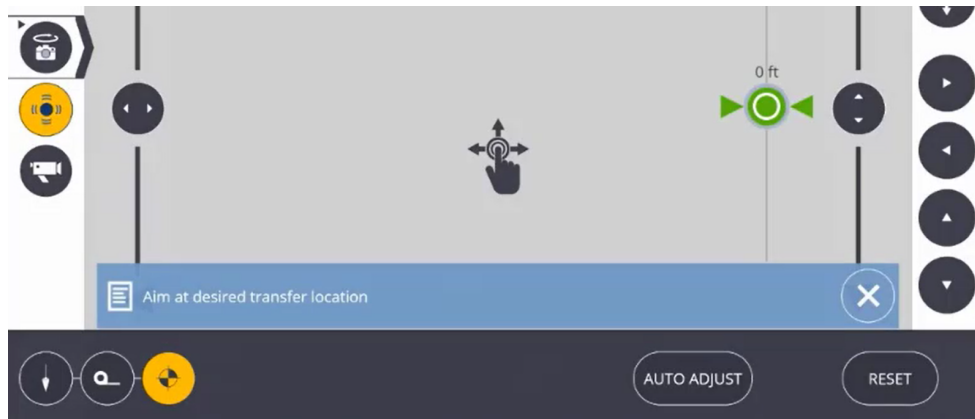

5. With the prism over the new elevation point to check for cut or fill. When aiming with the laser, move the laser to the correct vertical position and click **Auto Adjust** to move the laser to the correct elevation.
- 6.

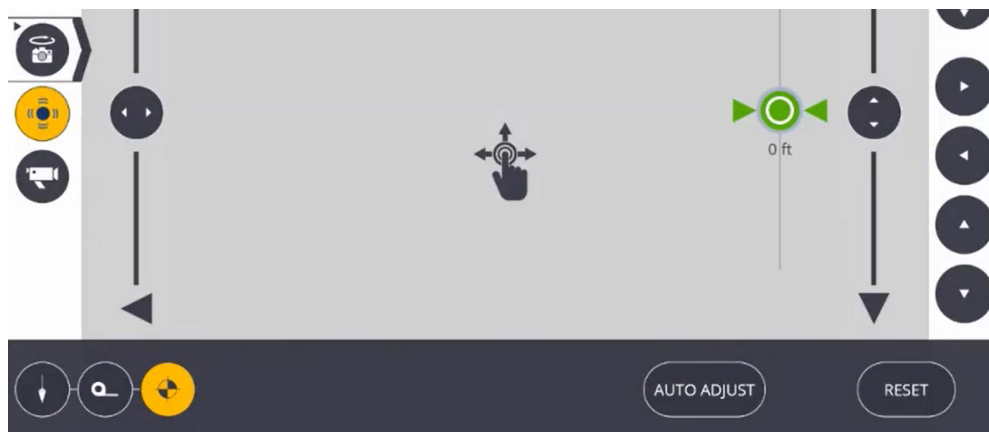

5.8 Set Up

5.8.1 Set Up - No Data

When you are starting a job with no reference data or points you can create your own reference relative to the structure or location information that you can measure. This may be the case in an open space or existing structure. To setup your RTS in this situation you can use the following procedure.

1. **Create** new job.
2. Tap the **Device** icon & **Setup**
3. **Measure** two points
4. Use **Input Form** to enter **Elevation**

5. Select **North** and **Base** Coordinate
6. Use **Rotation** icons to orientate coordinates



7. Tap **Set**.



5.8.2 Set Up - Unknown Location (Resection)

The RTS can be placed in a convenient location as long as there are at least two control points with a known location in the field of view. It is best practice to have the angle between the control points be within 45 and 135 degrees. The angle requirements help to ensure a more accurate calculation of the instrument position. If two control points are not between 45 and 135 degrees, or for a more refined set up, measure 3 or more control points and select the best measurements.

FieldLink uses a least square algorithm and computes the mean to determine station locations. The program will compute the mean error for both horizontal and vertical calculations and display the horizontal error in the application. An unknown location (Resection) requires a minimum of two measured locations preferably at 90 degrees to each other. Using more points will improve the calculation. To get the best results, it is desirable that each point used is equally spaced from each other around the total station at ranges that are greater or equal to the furthest expected layout/collection point.

FieldLink allows the user to accept "Unreliable" instrument setups if two control points within the 45 to 135 degree triangle are not available. You can tap **Set** even with the unreliable set up, but be cautious about laying out new points and be sure to check back to previously laid out points if possible. The best practice would be to add a third or fourth control point to the instrument set up to ensure accuracy and proper angular measurements.

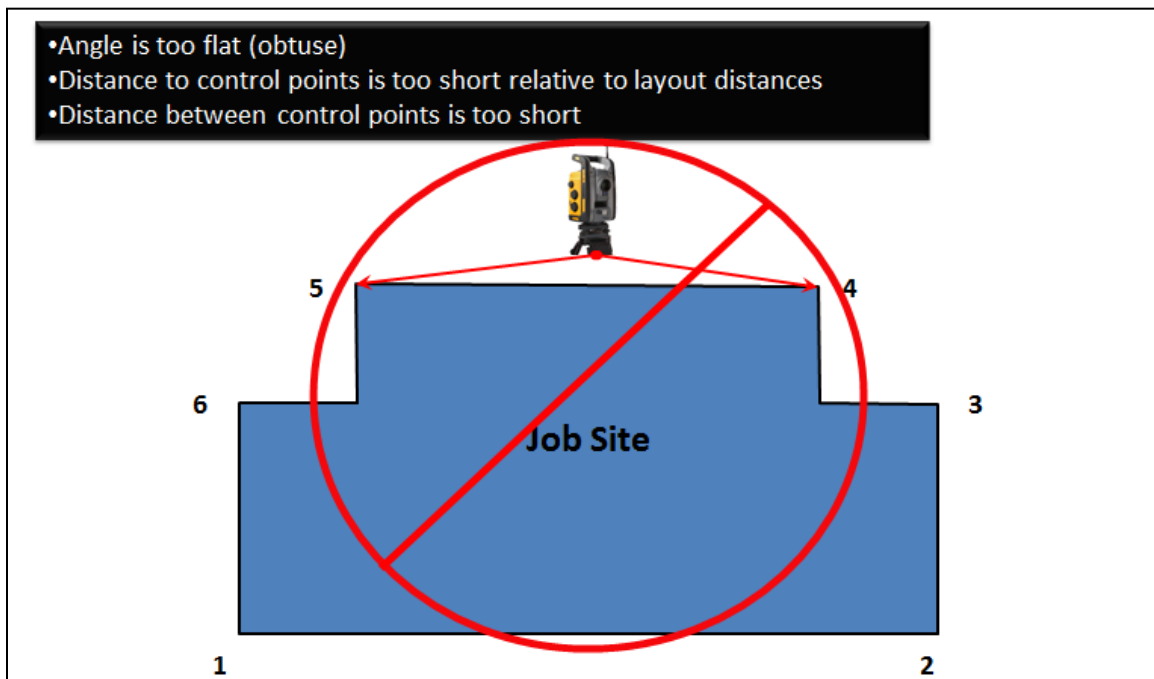
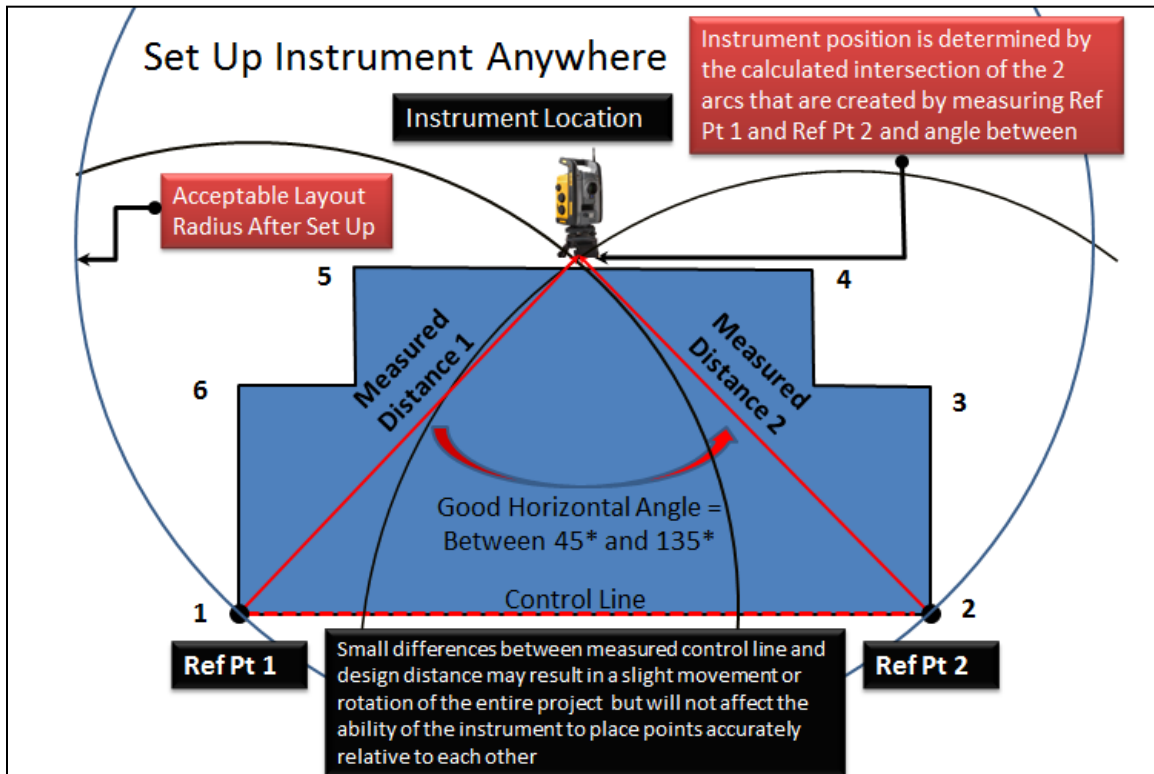

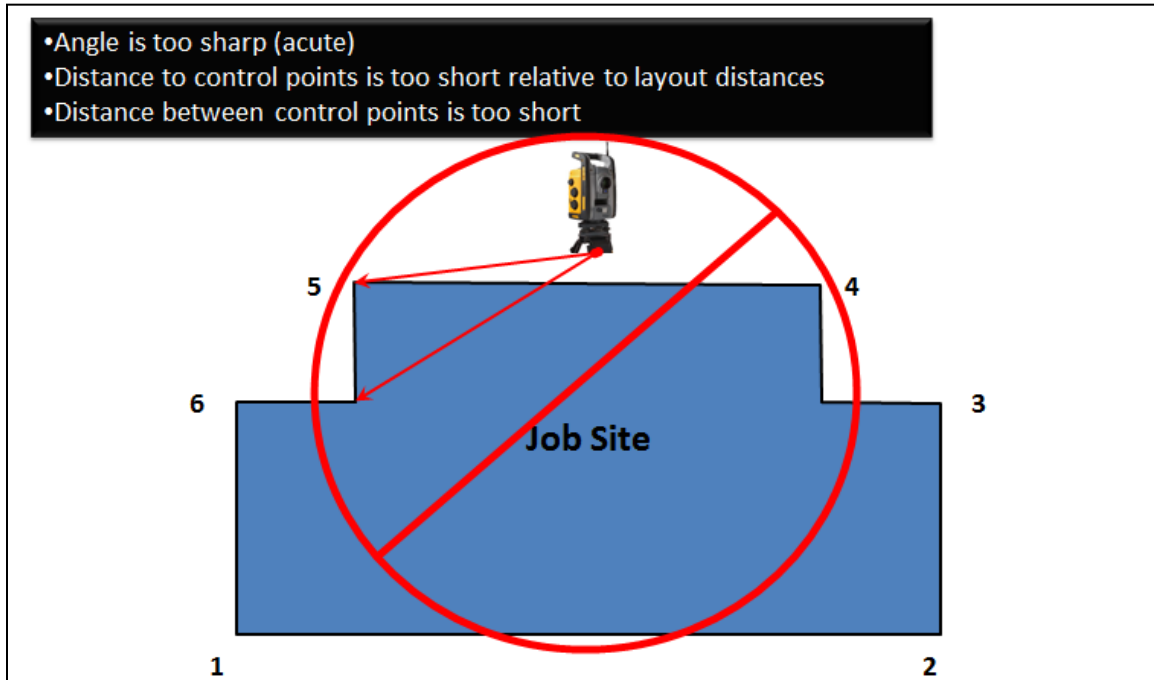

1. Tap the **Device** icon.
2. Tap the **Set Up** icon.
3. Tap on the first control point to be measured so it is highlighted with a blue circle. Make sure the rod height and prism type are correct in the **Prism** Settings, and the RTS is locked onto the prism at the correct point location (or pointed at the control point target directly in **LASER** mode).
4. Tap the **Shoot** icon in the upper right corner.



5. Once the point has been measured, it will appear as a solid blue circle.
6. You can now uncheck the **Include** box for each measured point if you do not want the point included in the Set Up calculations.
7. Tap on the second control point to be measured so it is highlighted with a blue circle. Make sure the rod height and prism type are correct in the **Prism Settings**, and the RTS is locked onto the prism at the correct point location (or pointed at the control point target directly in **LASER** mode).
8. Tap the **Shoot** icon.
9. If the two points are within the 45 to 135 degree triangle, the **Instrument Position Within** calculation will show a measurement.
10. If the two points are under 45 degrees or outside 135 degrees apart, the program will label the set up as "Unreliable". You can tap the **Set** icon to accept this set up or measure another point to add it to the calculations.
11. If necessary, tap on the third control point to be measured so it is highlighted with a blue circle.
12. Tap the **Shoot** icon. Repeat this process for additional control points as needed.
13. If you shoot more than 2 control points, you can tap on each measured point and uncheck the **Include** box in the lower message bar and see how it affects the calculated position next to **Instrument Position Within** dialogue box.
14. You can reshoot each point at any time by tapping on the measured point and tapping the **Shoot** icon.
15. Tap **Set** once you are satisfied with your results.
16. Tap the **Clear** icon to clear all measurements and start over.

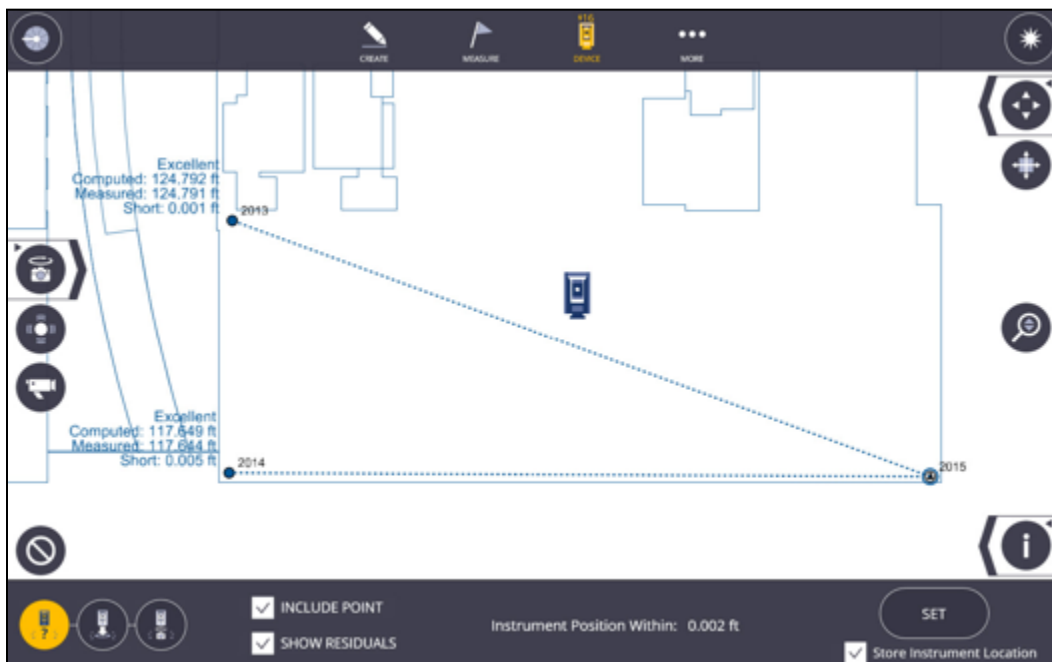

5.8.3 Set Up - Known Point

On the jobsite, it may be convenient to set up your RTS on a known point to conduct your layout. You will require another known reference point to complete the setup. Use the following procedure to complete the known point setup.

1. Tap the **Device** icon & **Setup**
2. Tap **Known Location** icon
3. Select **Instrument Location** point on map then **Select & Measure reference point**
4. Tap **Set**

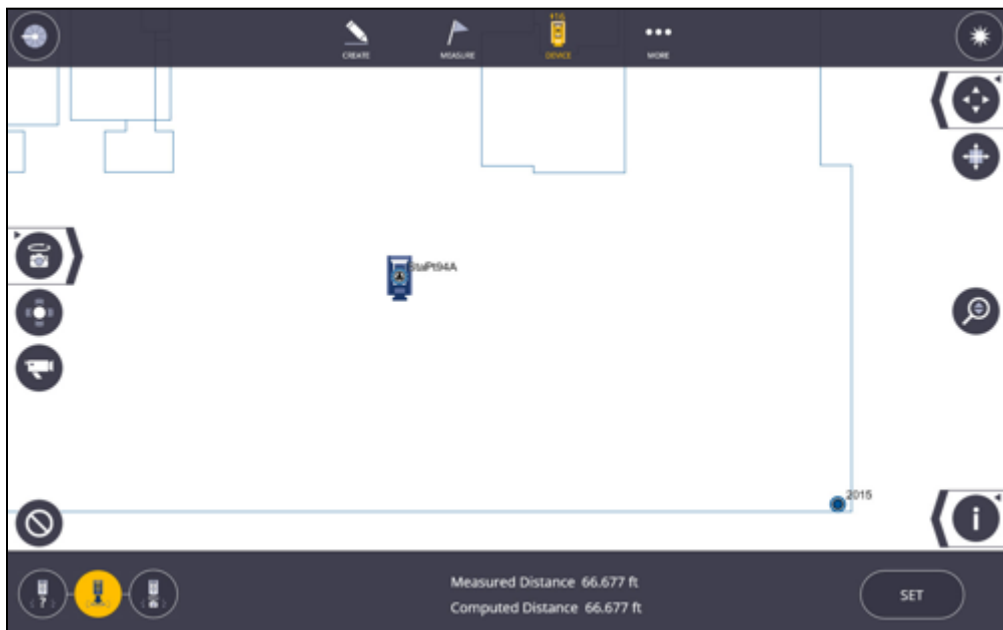

5.8.4 Set Up - Panorama

By using the panorama picture taken with your RTS or RPT device you have the option to use the panorama to select targets and have the instrument automatically measure the targets and assign them to execute a station setup. Here are the steps to complete a panorama setup:

5. Tap **Device** icon and select **Setup**.
6. Tap the **Panorama setup** icon.
7. If you have a panorama that you have just taken it will be displayed on the screen, if you have a saved panorama from the existing station tap **Open** and select the panorama or tap **Take New** to capture a new panorama.
8. You will be promoted to **select at least 2 targets** or more targets in the panorama. Scroll around the panorama and select the targets.

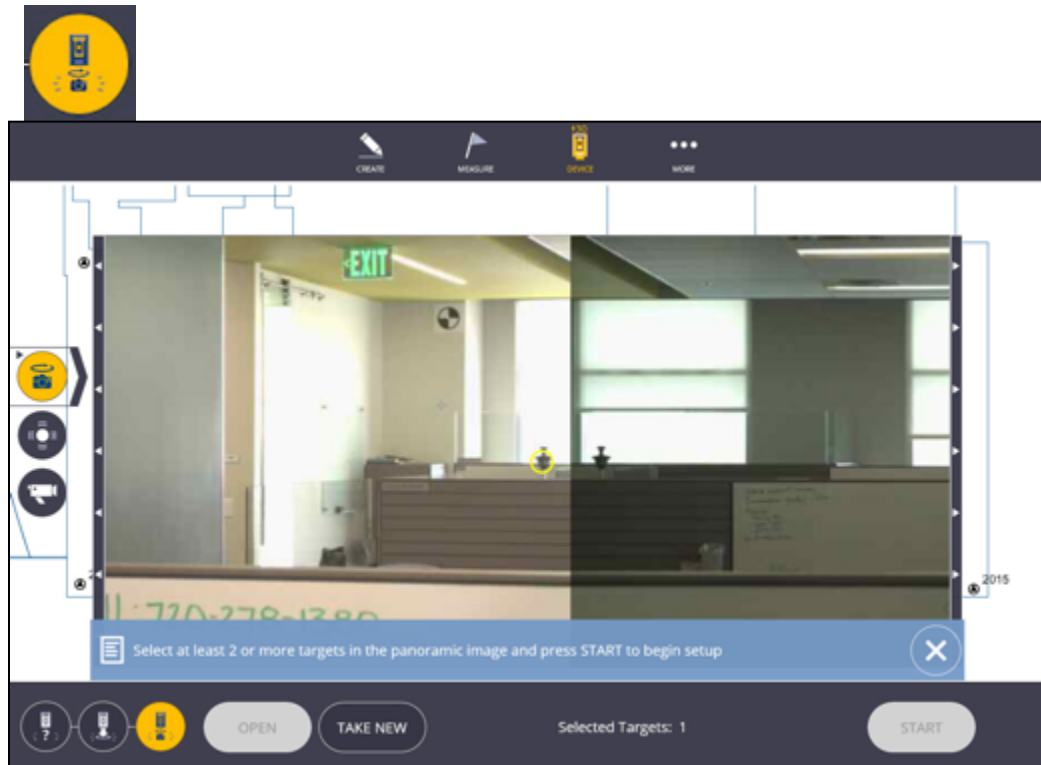

9. Tap **Start**. The instrument will automatically turn, lock onto and measure each target.
10. A toast message will appear stating Unable to resolve instrument position and asking you to select a point on the map that the instrument is currently aiming at. **Select a point** on the map screen and tap **Assign**. The instrument will then point to the next target, repeat the process for each target.
11. Select option too Store Instrument Location if desired.
12. Tap **Set**.

5.8.5 Set Up - Use Rounds (Optional Module)

If you have purchased the optional Site Control Module, you will have the option to "Use Rounds" for both the Known and Unknown Location Set Up.

1. Tap **Device** icon and select **Setup**.
2. Tap the **Known** or **Unknown Setup** icon.
3. Check the **Use Rounds** box.
4. You will then be prompted to set the Face Order (F1/F2, F2/F1, or F1 only), the number of Rounds (Shoot each point 1 - 10 times), and Measure Mode (High or Fast Precision).
5. Press the **Shoot** icon to start the Rounds collection process.

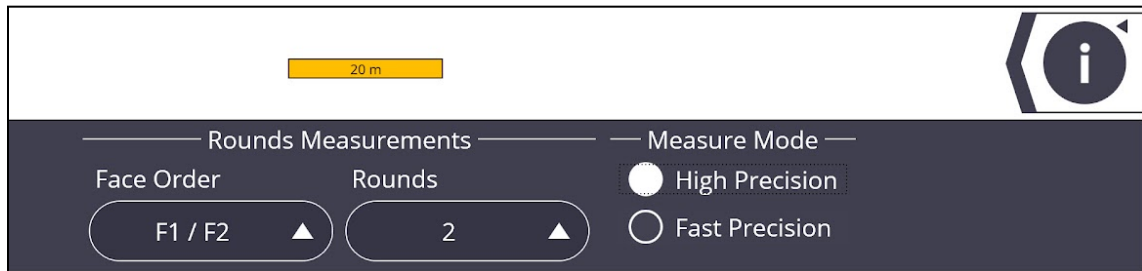
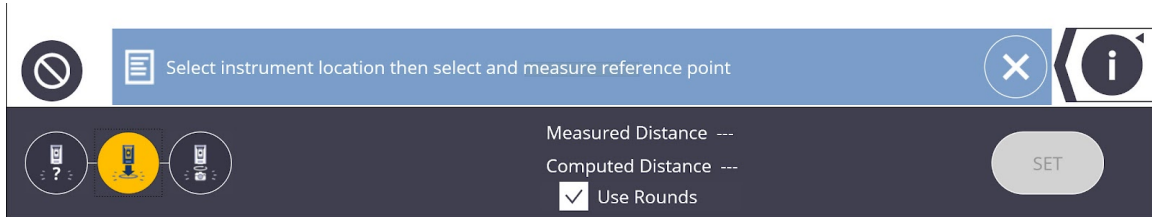

5.8.6 Set Up - Grid Lines

Note: For absolute best accuracy setup, it is recommended a standard resection option be used in lieu of Grid Line setup. Grid Line setup should be used as a last resort.

1. Tap **Device** icon and select **Setup**.
2. Tap the **Grid Line Setup** icon.

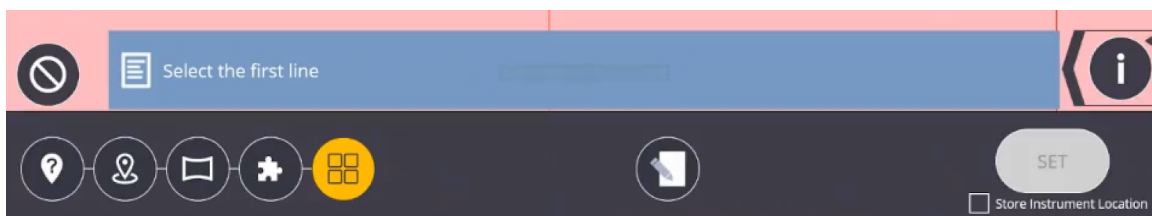

3. **Select** the first gridline.
4. **Measure** the first point on the selected grid line.

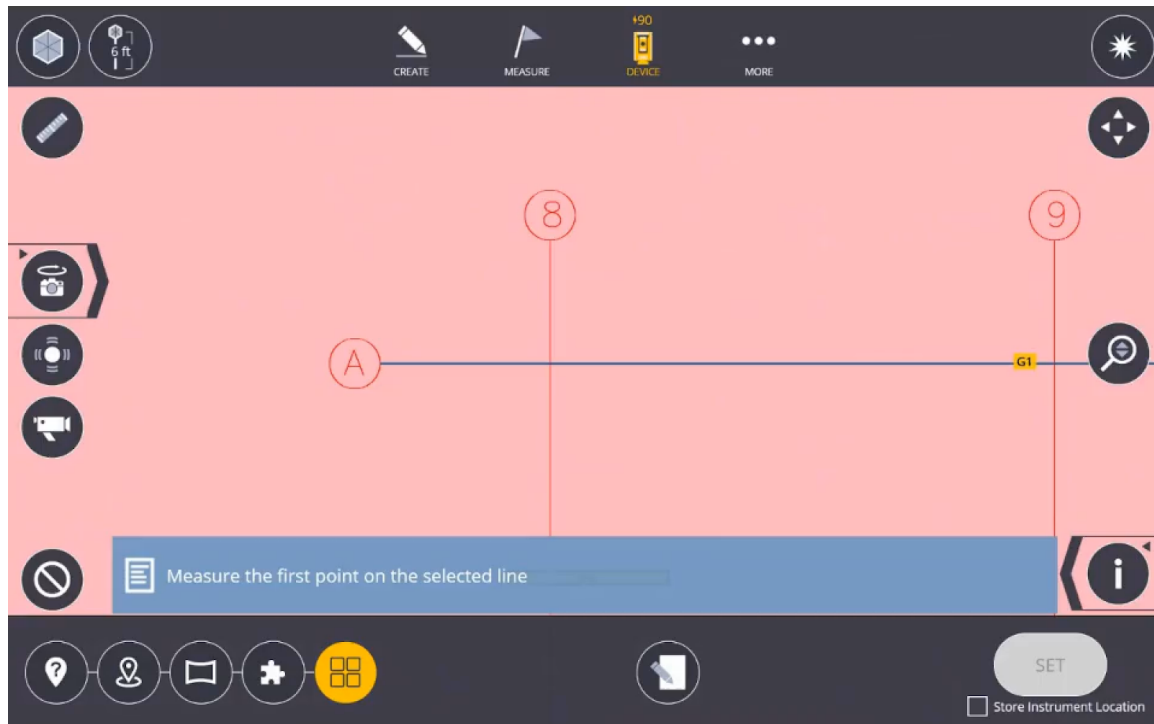

5. Measure the second point along the same grid line.
6. **Select** the second grid line.

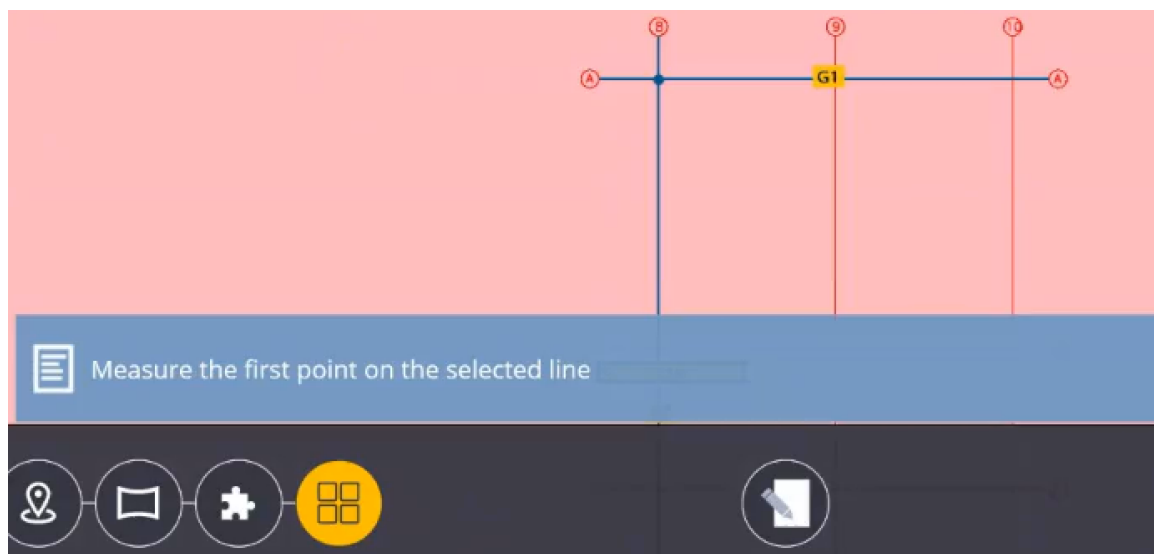

7. Measure the first point along the grid line.
8. Measure the second point along the grid line.

9. Select the station to position the instrument.
10. If the **Deviation** is acceptable the select **Set**.

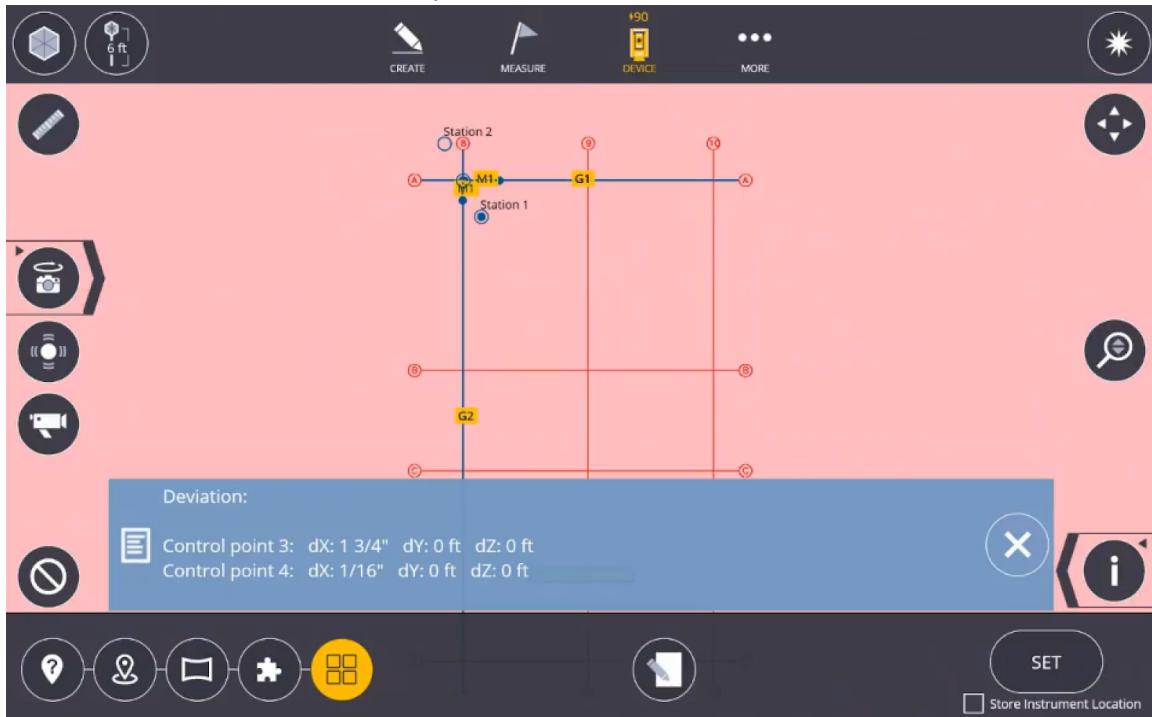

11. Once **Set** is selected, a toast will appear notifying the user that a reference elevation is recommended for the setup. If a reference elevation is desired, selecting the Reference Elevation button will allow the user to aim the instrument to a feature, take a measurement and input the elevation of choice to use as reference for the rest of the setup.



5.8.7 Component Based Set Up

This feature was created to allow users to set up on an unlevel surface to help with fabrication items and ensure accuracy to the modeled item.

- Note: When using a scanner it is recommended only using one scan.

With the Component Based Set Up, a rigid transformation of the model is performed, requiring at least three points. When there are more than three points, a least squares solution is obtained. The centroids of the map data and the measurement data is calculated. This allows us to calculate optimal rotation and translation matrices that are used to find the setup location. Error is the square distance error between the points in the two datasets.

12. Tap **Device** icon and select **Set Up**.
13. Tap the **Component Based Setup** icon.

14. Select and measure at least 3 points on the component to set the new level for the component. Use the Layer and/or Section Box Tools to isolate a specific component to use for set up and layout.
15. Once you measure at least 3 points, the position of the instrument will be shown and a residual setup error will be visible. Tap **Set** to complete the setup and start laying out additional component connection points.
16. The Component Set Up will change the Laser to Standard Aim in lieu of Visual Layout in order to process the new component level.

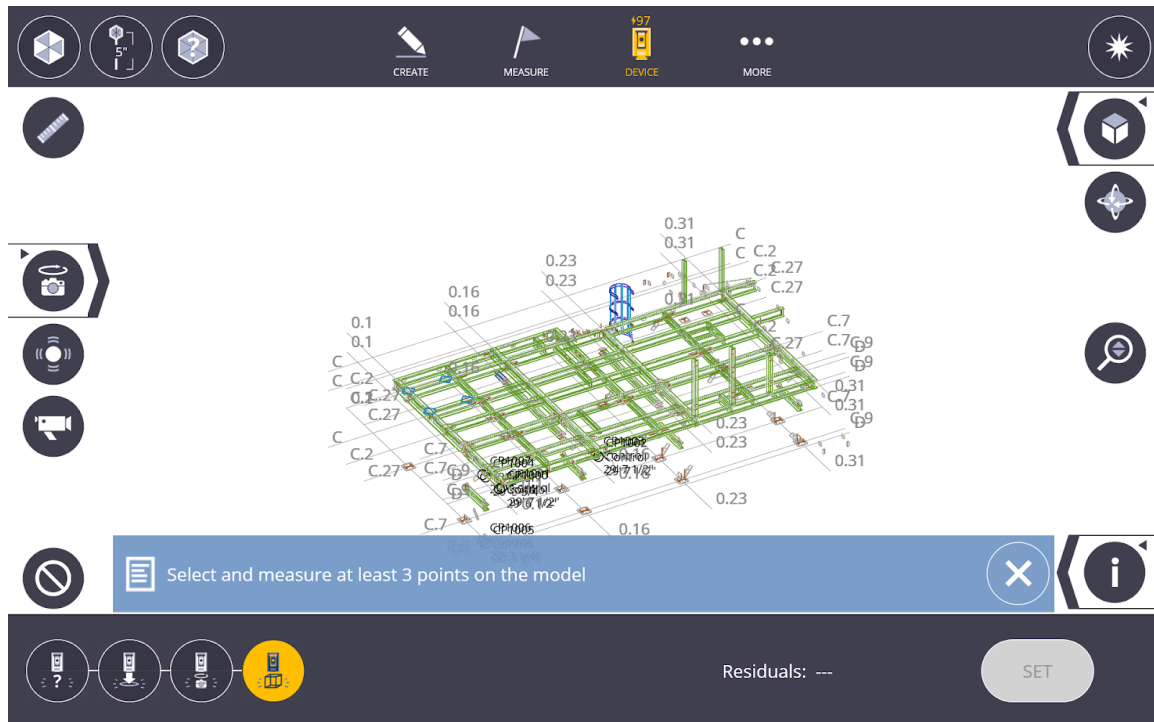

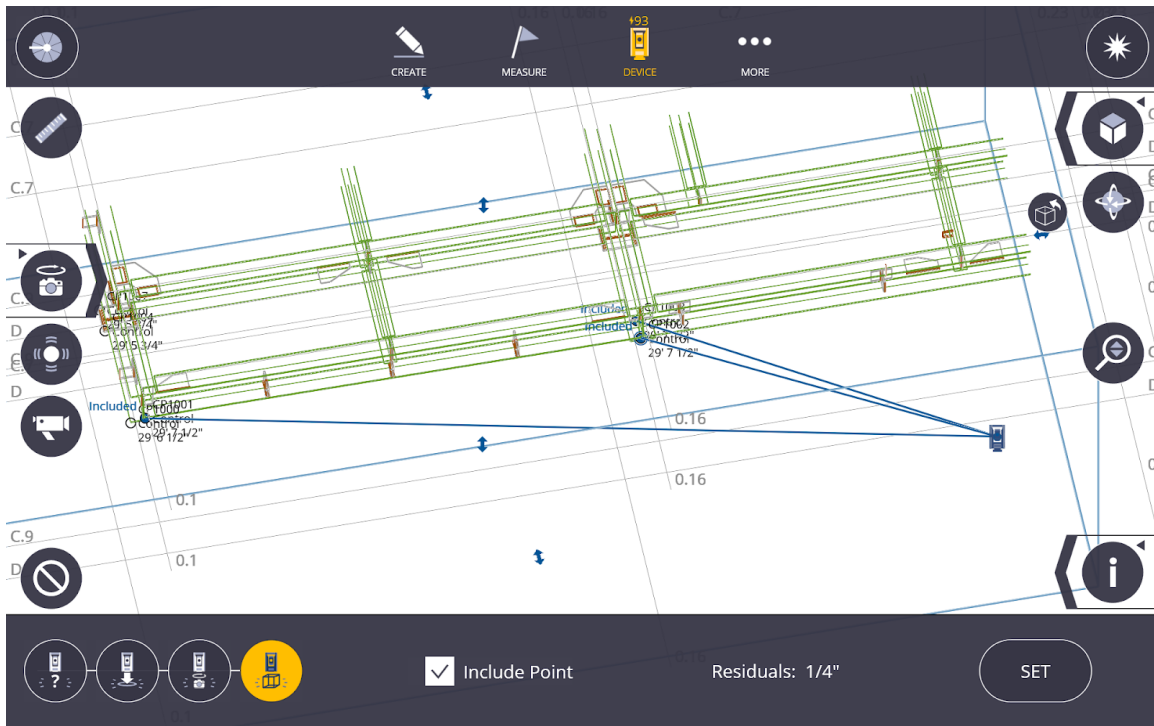
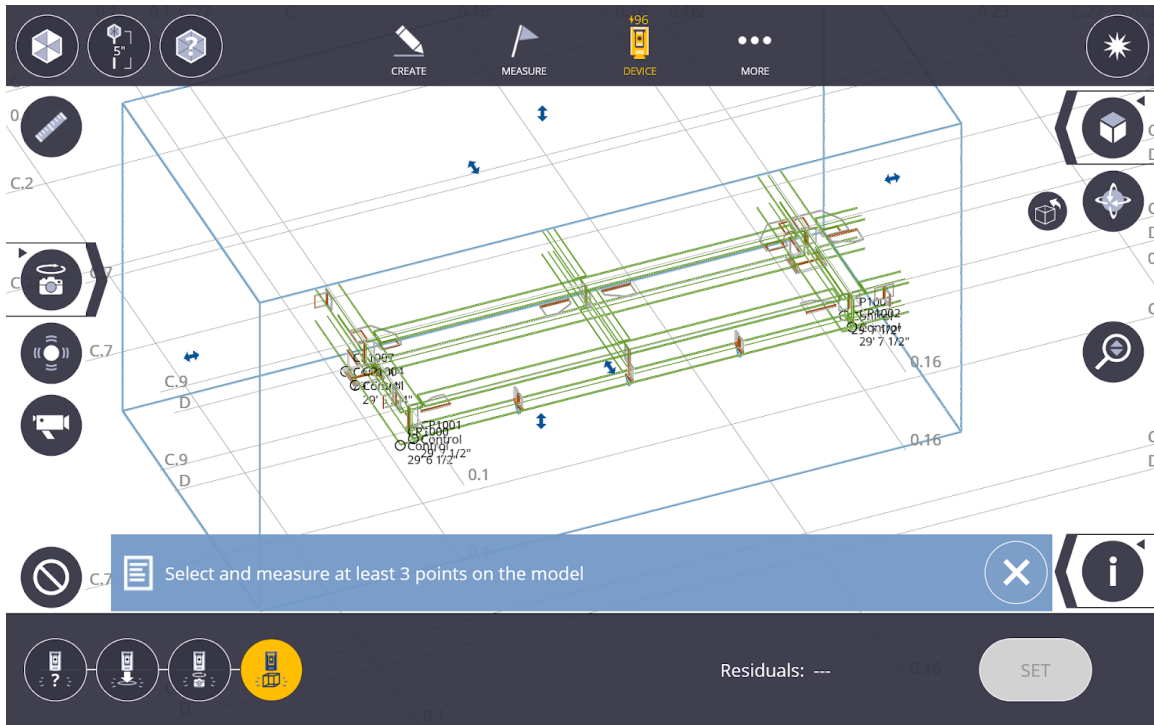

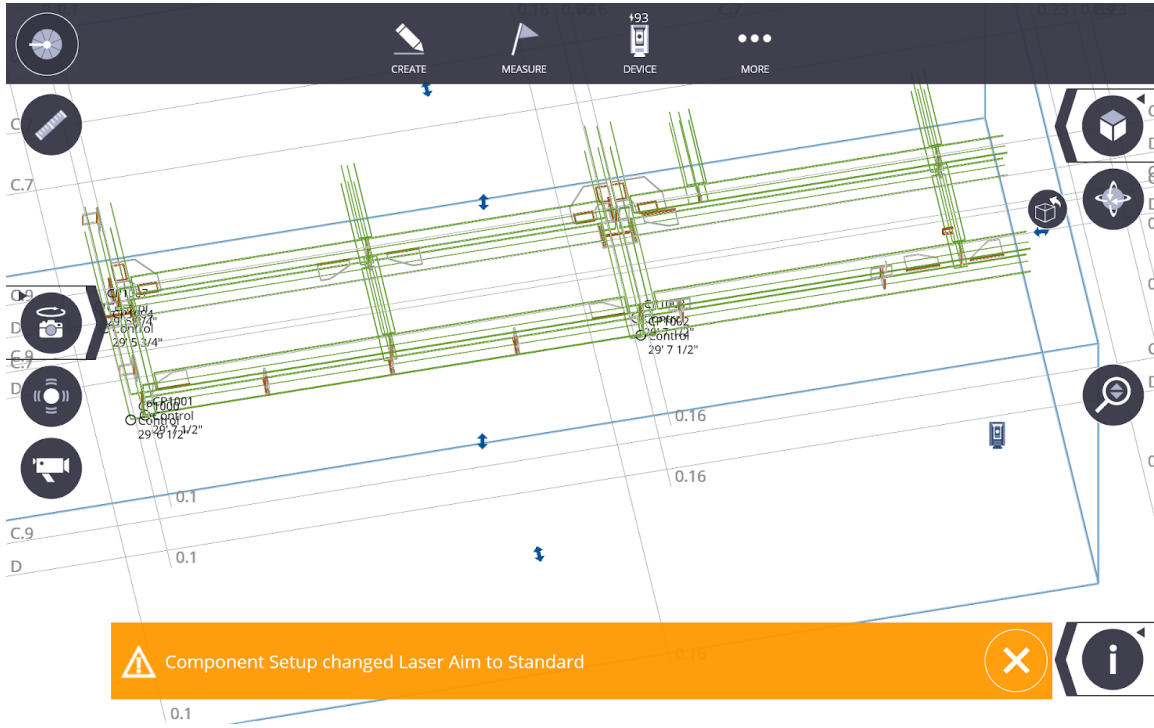

5.8.8 GNSS Set Up - Unknown Location

The Base Station can be placed in a convenient location as long as there are at least three control points with a known location in the field of view. It is important to place control points with good geometry balance around the job site.

Warning: Performing this setup will rewrite and previously stored calibration files.



Avoid setting the control in only one area of the site.

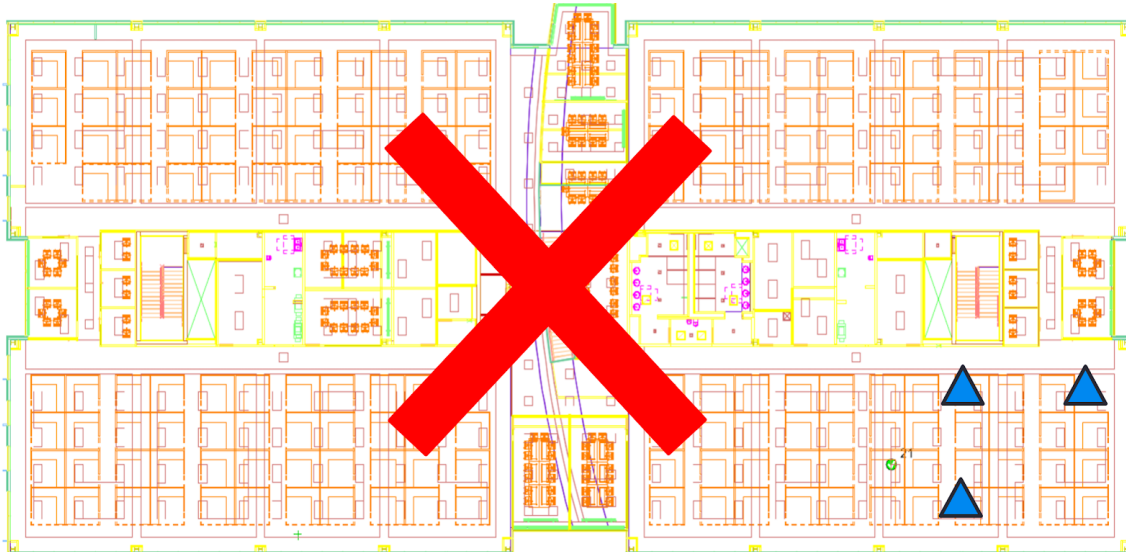

1. Select a point from the map, set your Rover with pole at that location on the job site, and select measure. Repeat step 1 for all three of your control points
2. After you measure all 3 points your horizontal and vertical residuals will populate in the bottom taskbar and you can hit the Set button

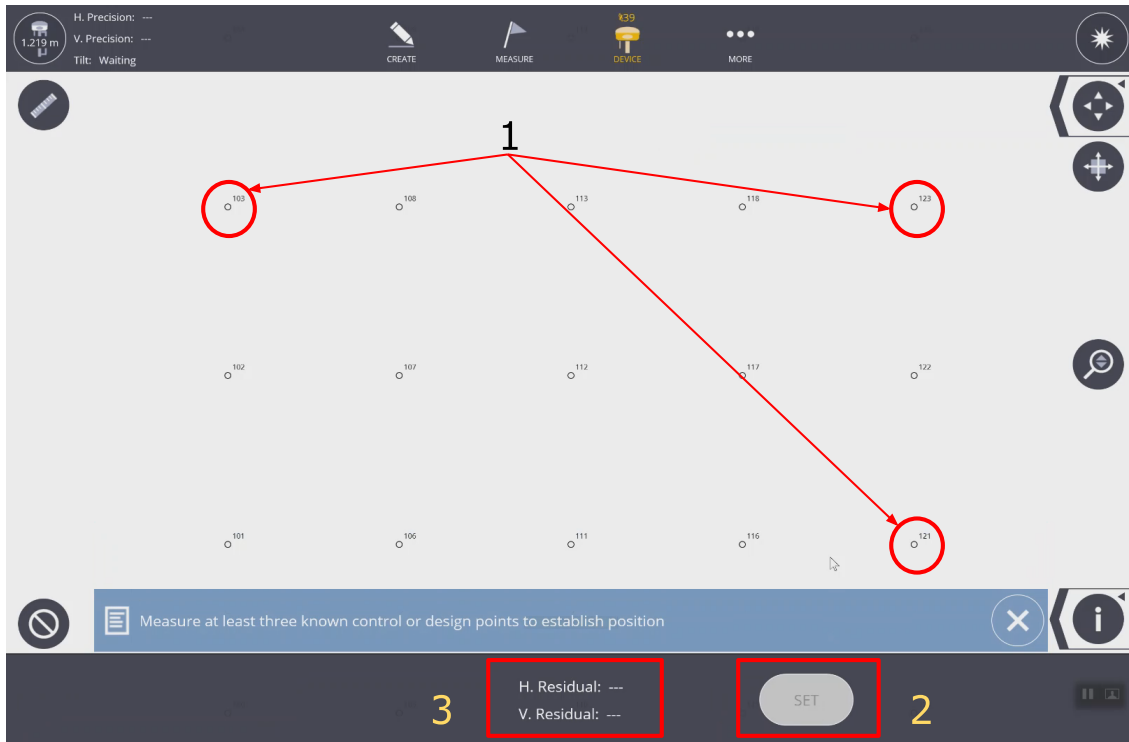

3. You will then see the Setup successful toast



5.8.9 GNSS Set Up - Known Location

On the jobsite, it may be convenient to setup your Base Station on a known point to conduct your layout. It is recommended to verify the quality of the set up by shooting another known reference point before layout. Use the following procedure to complete the known point setup.

1. Select Basepoint location on map.
2. Select Set Over Point

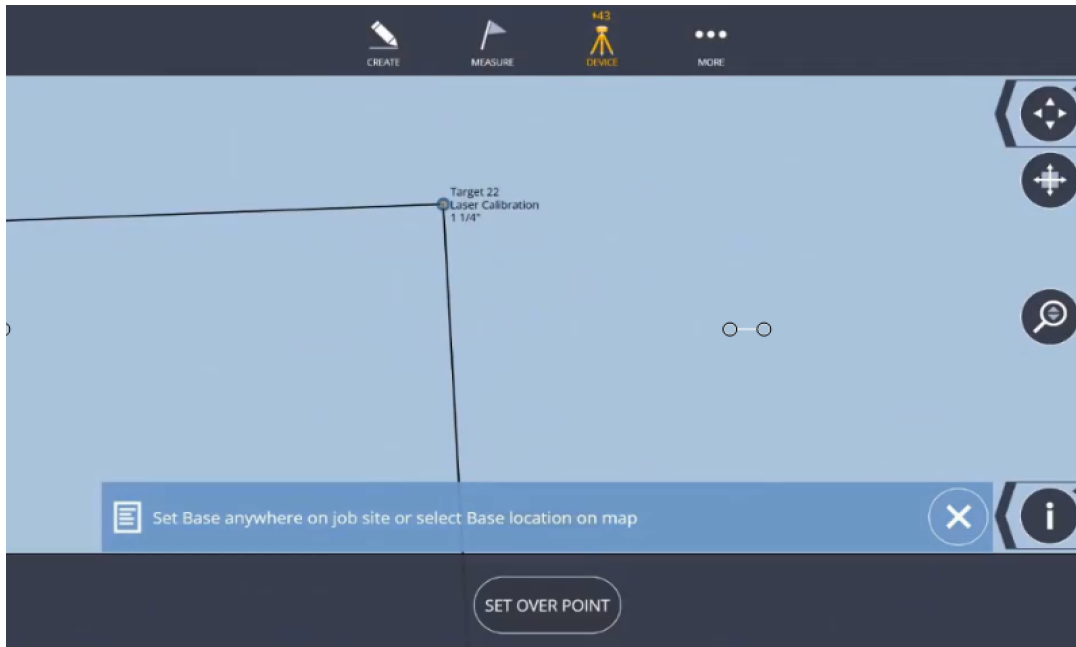

3. Once Base Station is established, select Find Rover



4. Select Rover and wait to see the Rover connection successful.



5. Once the Rover is connected and receives corrections, GPS precision will be in tolerance.



5.8.10 GNSS Set Up - No Data - Can be performed in a job with no imported points or model data.

1. Select **More/Projects**
2. **/Manage**
3. Select **Create**
4. Name the job and select **Create**

New Job Name

Location

CREATE SAVE AS OPEN DELETE Sort by Name

5. Select **Device/Set Up**

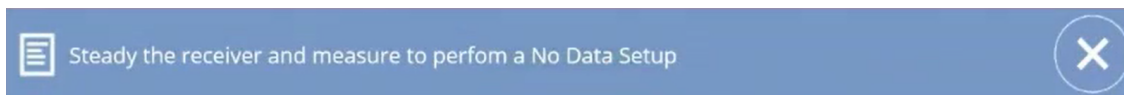

6. Steady the receiver and select **Measure** to complete setup.

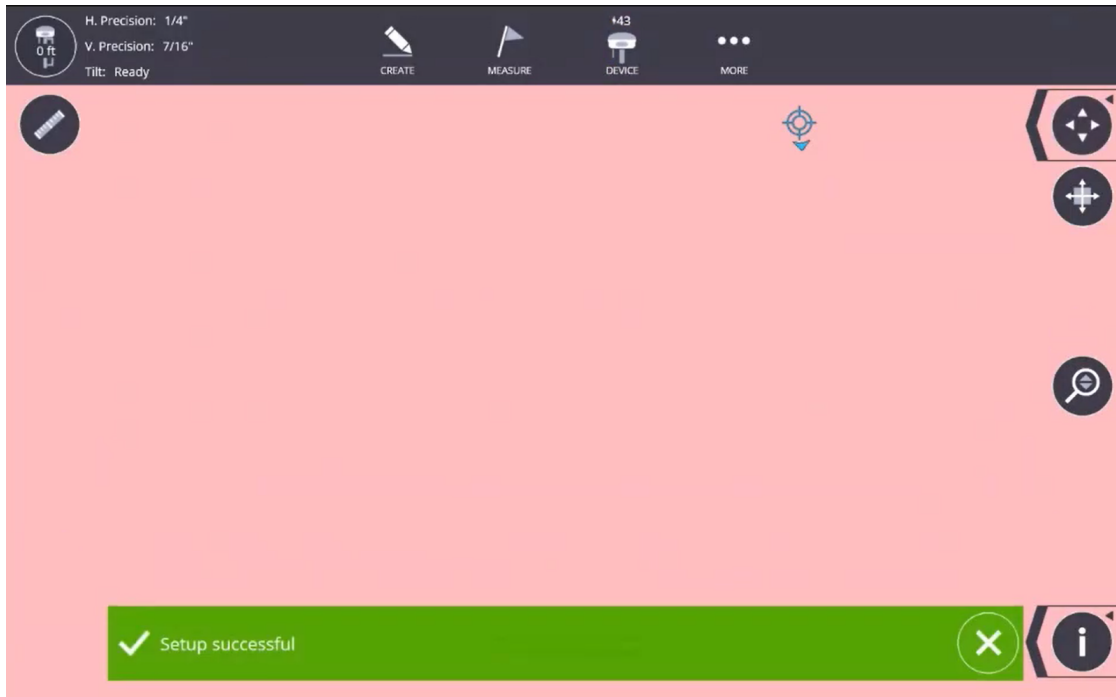

5. Traverse

5.9.1 Traverse (Optional Module)

In order to check control points, add control points, or even establish benchmarks around the project, we added the Traverse feature. The Traverse feature requires you set up on a known point and have at least one other known control point. These points must be established as Control Points with the triangle symbol under the Point Manager tool. This option is not available with the Rapid Positioning Tool (RPT).

Two types of mathematically CLOSED Traverse are supported in FieldLink. These are:

POLYGON - In the polygon traverse, as shown in Figure (a), the lines return to the starting point, thus forming a closed figure that is both geometrically and mathematically closed.

LINK - Link traverses finish upon another station that should have a positional accuracy equal to or greater than that of the starting point. The link type (geometrically open, mathematically closed), is illustrated in Figure (b).

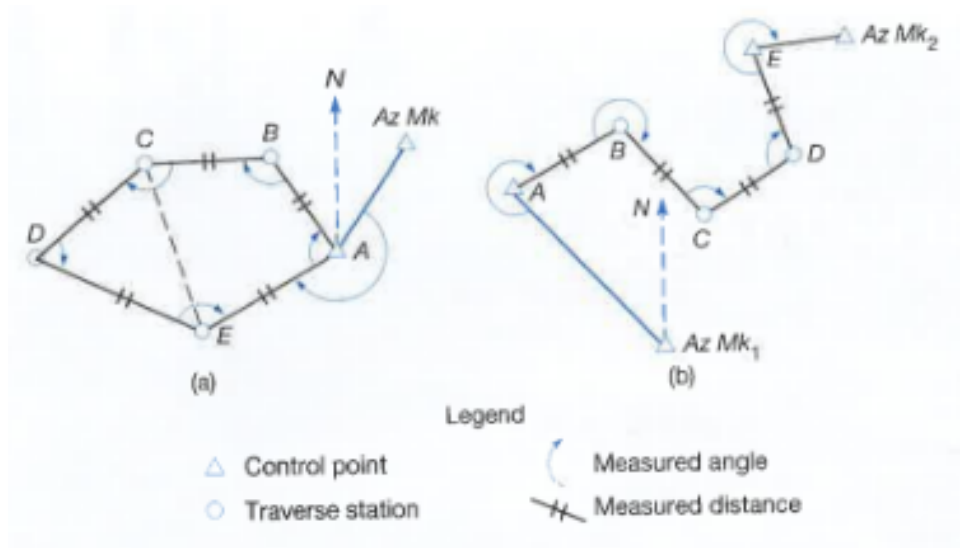

To conduct a traverse:

1. Tap the **Device** icon & then **Traverse**.
2. A message will appear telling you to "Select and position the instrument over a known control point".



Tap on the point for the desired instrument location.



3. A message will then appear telling you to "Configure the targets and select the backsight point".

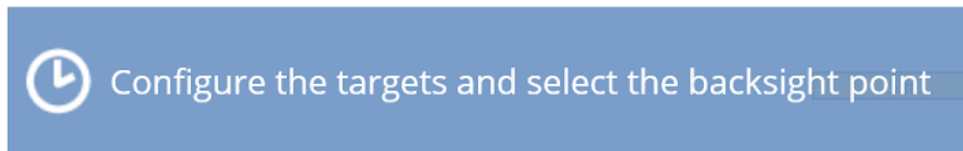

4. Press the **Input Form** to enter the Backsight Prism type, Rod Height, and select the Backsight from the map view when done. Enter the Foresight Prism Type, Rod Height, Point Name, Point Description and Layer (Create New or Enter Known Point).

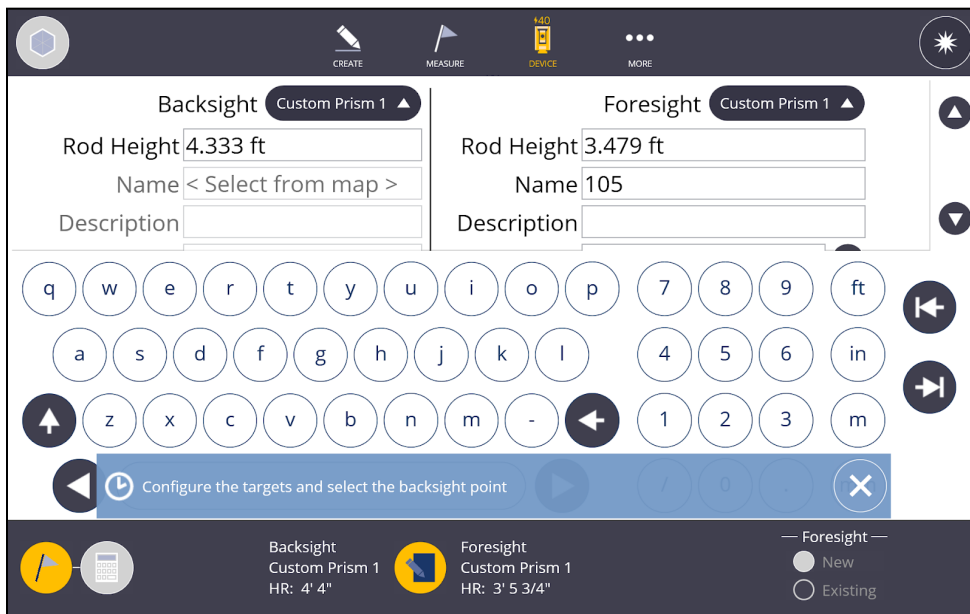

5. Press the Input Form again to return to the map view. Make sure the instrument location has been selected, then aim at the backsight point and press the measure button.
6. Aim at the Foresight location and press Measure again.
7. The instrument will then go through a series of Face 1, Face 2 and/or Backsight/Foresight measurements based upon the settings for Rounds.
8. Once the Rounds measurements are complete, you can Add a Round to that set of measurements, or Store the point.

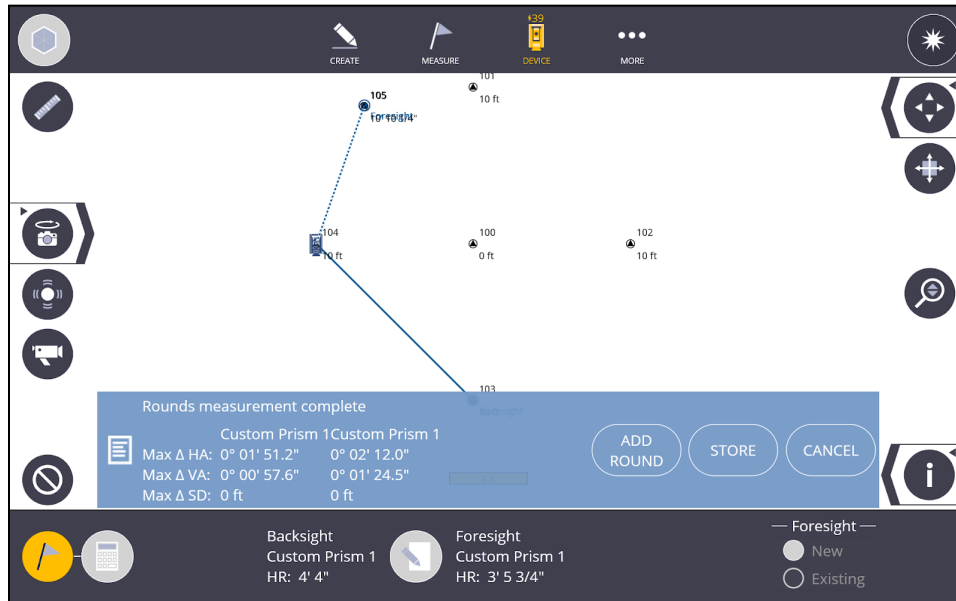

9. Place the instrument over the Foresight location, Configure the targets using the Input form, and place the actual prisms over the new Backsight and Foresight location.
10. Aim the instrument at the first location, which is now set to the Backsight, and press Measure.
11. Aim the instrument at the new Foresight location and press Measure.
12. Repeat this process for the remaining control points.

Traverse Calculation and Report

CALCULATION DEFINITIONS:

ADJUSTMENT

- Transit - In this adjustment method, it is assumed that directions are measured with higher precision than distances.
- Compass/Bowditch - In this adjustment method, it is assumed that distances and directions are measured with consistent precision.

TOLERANCE

- Horizontal Precision - Defines the lower limit for horizontal precision. Precision is the ratio of traverse length to horizontal misclosure.
- Vertical Precision - Defines the lower limit for vertical precision. Precision is the ratio of traverse length to vertical misclosure.

ERROR DISTRIBUTION

Angular

- Proportional to distance - Adjustments are weighted more heavily for angles with shorter traverse lines than angles with longer traverse lines.
- Equal proportions - Angle adjustments are weighted equally regardless of the length of the traverse lines.
- None -No angle adjustment is performed.

Elevation

- Proportional to distance - Adjustments are weighted more heavily for elevations with longer traverse lines than elevations with shorter traverse lines.
- Equal proportions - Elevation adjustments are weighted equally regardless of the length of the traverse lines.
- None - No elevation adjustment is performed.

To Execute a Calculation and Save a Report:

1. Tap on the **Calculation** Icon



2. You can review the **Traverse Result** information
 - a. Summary
 - b. Station Information
 - c. Distance Adjustments (Four difference sets of data can be review)
 - d. Horizontal distances before adjustment
 - e. Horizontal adjustments
 - f. Vertical distances before adjustment
 - g. Vertical adjustment
3. You can **Accept** and **Save**, OR
4. Tap the the **Input** Form
5. Select the **Adjustment** Type (Compass or Transit)
6. Input the *Horizontal* and *Vertical Precision*
7. Select the **Angular** and **Elevation** Distribution (Proportional to Distance, Equal Proportions or None)

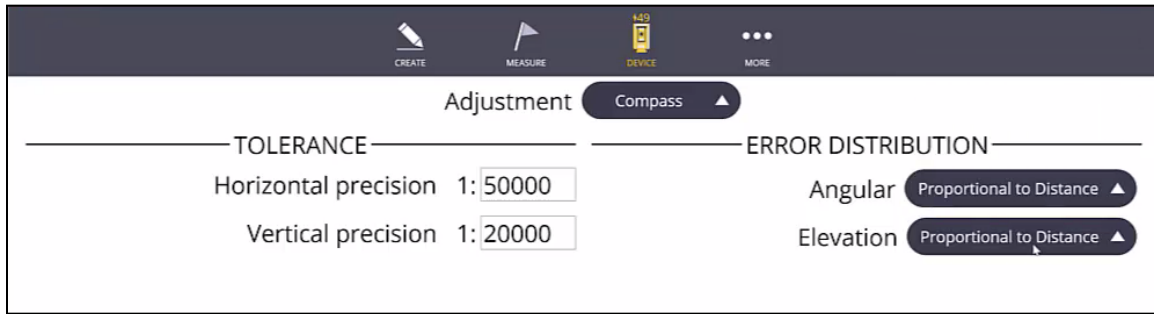

8. The Traverse Results will automatically be recalculated
9. Tap **Accept** and **Save**
10. To review the saved report go to the default location in most cases this will be Documents/FieldLink/Reports/Traverse Reports.

6. Measure Mode

Once we have connected to the instrument and have Set Up the RTS on the project using control points, you can now Collect and Lay Out points, lines and arcs. You can also utilize the automatic collection of square cateye control points and subsequent Auto Locate and autostationing information using this mode.

6.1 Settings

1. Tap the **Measure** icon.
2. Tap the **Settings** icon. The layout settings icon will be highlighted.
3. Tap the **H. (Horizontal) Tolerance** arrow to select from 1", 1/2", 1/4", 1/8" or 1/16", or 25, 12, 6, 3, 1.5mm. Or you can choose the Custom Tolerance option and enter in your desired measurement. Points measured in the field that are outside this tolerance setting will show a red lay out flag on the screen indicating the point was out of tolerance.
4. Tap the **V. (Vertical) Tolerance** arrow to select from 1", 1/2", 1/4", 1/8", 1/16", or Ignore, or 25, 12, 6, 3, 1.5mm. Or you can choose the Custom Tolerance option and enter in your desired measurement. Points measured in the field that are outside this tolerance setting will show a red lay out flag on the screen indicating the point was out of tolerance. If you select "Ignore", vertical elevation measurements will not be used for tolerance flags.

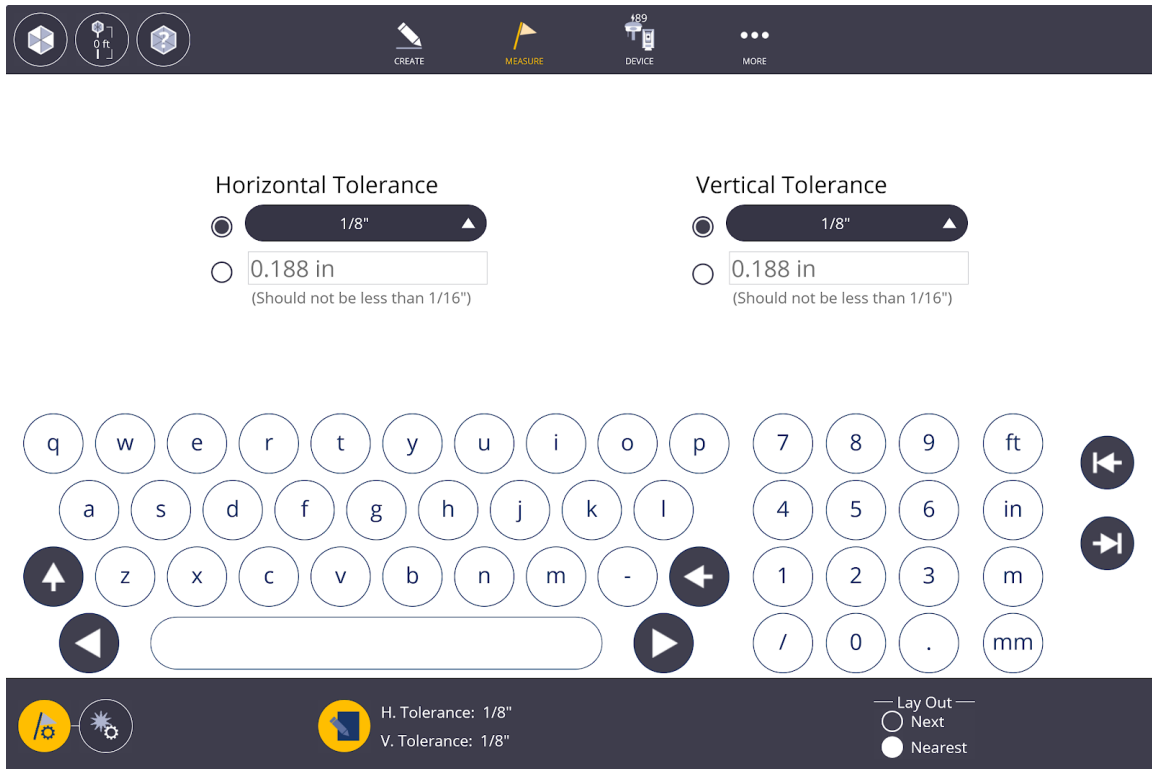

5. Select on the **Next** or **Nearest** Lay out selection box to automatically select the Next sequential point (ex. 100, 101, 102, 103) or the Nearest point to your prism or LASER measurement. The **Nearest** setting is usually the most efficient.
6. Tap the Measure Settings button.
7. Select **Standard** or **Visual Layout** for Laser Aiming. Standard mode will aim the laser beam at the X, Y, Z location and give correction distances. Visual Layout mode will move the laser beam to the correct X, Y location based upon the adjusted elevation.
8. Select **High Precision** or **Fast Precision** Measure Mode. High Precision will take an average of the measurements over a few seconds, Fast Precision will take an instant measurement.



6.2 Collect

See Section 5 for instructions on Instrument Set Up. Once the Instrument Set Up has been completed, you can Collect and/or Lay Out without performing another Instrument Set Up. Use the Collect Points process to save project information such as existing utilities, foundations, anchor bolts, or any other type of project information. Use the Collect Linework process to save information such as ceiling or floor lines, inside and outside building corners, doorways, windows, utilities or any other type of linework information to help save time by creating drawings or 3D model information automatically in the field.

6.2.1 Collect Points

1. Tap **Measure Mode** icon.
2. Select **Collect**.
3. The **Point** icon will be automatically selected.
4. Tap the **Input Form** icon. Input the *Point Name* and *Description*. Place the points on a specific layer by tapping the Layer drop down menu, or type in a new *Layer* to create a new layer name.
5. Select optional **Control Point** check box if you are measuring a control point
6. Tap **Camera** icon to capture and store image with the point
7. Utilize the **Joystick** or **Vision** modes to aim at the item or prism.
8. Place the prism rod on the point or aim the laser directly at the item to be measured and tap the **Shoot** icon. The prism or laser position is displayed with the symbol  in Map View.
9. When ready to collect square cateye targets to be used for autostationing, make sure the **Control** point is selected and tap **Auto Collect**. This is only available when using a RPT600. To manually change points to control points, see Section 4.3. For more information on autostationing, see the next

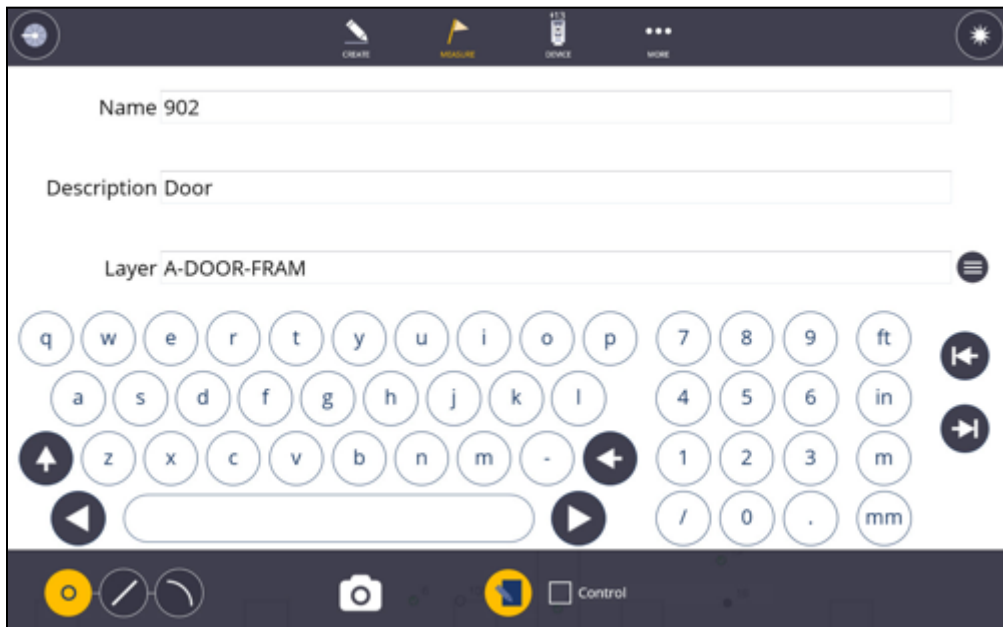

6.2.2 Collect Line

1. Tap on the **Line** icon to measure points and create lines between each point as you measure.
2. Tap the **Input Form** icon. Input the **Point Name** and **Description**. Place the points on a specific layer by tapping the Layer drop down menu, or type in a new **Layer** to create a new layer name.
3. Select the points and lines to be collected as **Measured**, **Design**, or **Control**. **Measured** points and lines will be indicated with a solid dark circle and cannot be laid out without saving the point under a different name. **Design**

points will be indicated with an open circle and can be laid out again immediately. **Control** points will be indicated with a triangle inside an open circle.

4. Utilize the **Joystick** or **Vision** modes to aim at the item or prism.
5. Place the prism rod on the point or aim the laser directly at the item to be measured and tap the **Shoot** icon.
6. Tap the Close Line icon on the screen to automatically create a line to close the line segments.



7. Points or lines that have been collected as Design points can be connected to other points or connected with linework using the Create Linework mode.

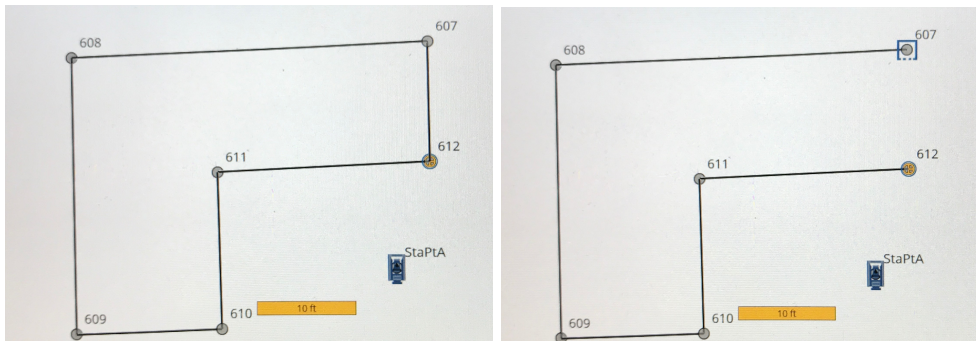

6.2.3 Collect Arc

1. Tap on the **Arc** icon to three points to that form the arc.
2. Tap the **Input Form** icon. Input the **Point Name** and **Description**. Place the points on a specific layer by tapping the Layer drop down menu, or type in a new **Layer** to create a new layer name.
3. **Measure three points** that define the arc. You will see the arc being constructed as you capture the first two points then when the final point is capture the arc is finalized and displayed on the map display. The Arc Diameter and Arc Angle are indicated during collection.



6.2.4 Collect Circle

1. Tap on the **Arc** icon to three points to that form the arc.
2. Check the **Circle** option box
3. Tap the **Input Form** icon. Input the **Point Name** and **Description**. Place the points on a specific layer by tapping the Layer drop down menu, or type in a new **Layer** to create a new layer name.
4. **Measure three points** that define the arc. You will see the arc being constructed as you capture the first two points then when the final point is capture the arc is finalized and displayed on the map display. The Arc Diameter and Arc Angle are indicated during collection.



6.2.5 Collect Points Using Rounds (Optional Module)

1. Tap **Measure Mode** icon.
2. Select **Collect**.
3. The **Point** icon will be automatically selected.
4. If you have purchased the optional Site Control Module, you will have the option to select the **Rounds** boxes. Also select the **Control** box prior to running the Rounds routine.
5. After selecting Rounds, you will need to select the Face Order, Number of Rounds, and Measure Mode.
6. The results of the Rounds process will show in the bottom of the screen.

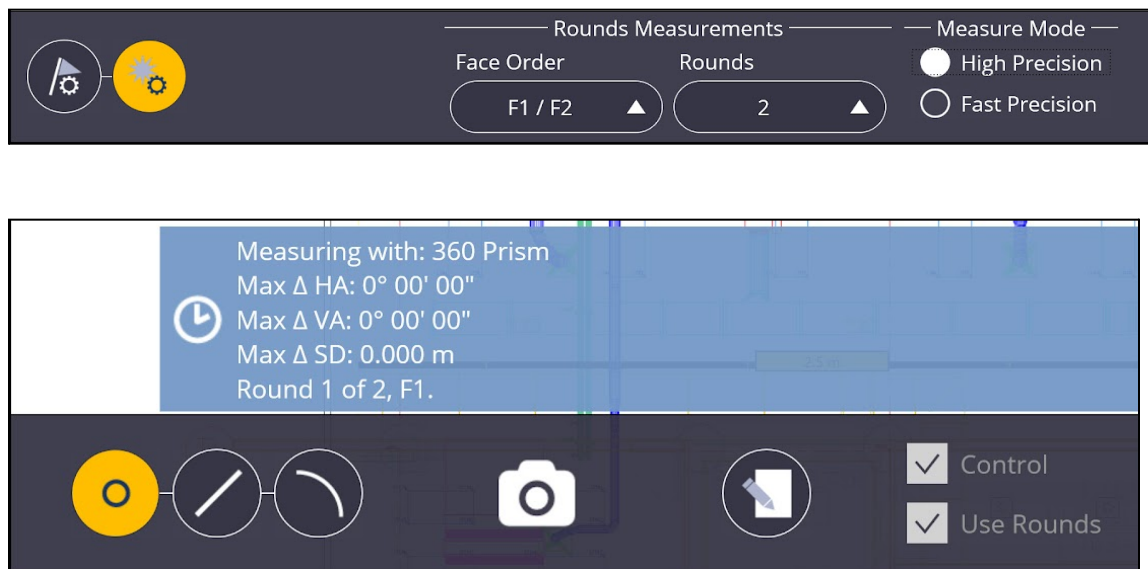

6.3 Layout

6.3.1 Layout Points

Points can be created within FieldLink or with office software such as Vico, Tekla, SketchUp, Trimble Business Center, Trimble Field Points for AutoCAD or Revit, or even other non-Trimble software. The points measured should be compared to the model to ensure any deviations, changes or issues are documented in the as-built model or drawings.

1. Tap the **Measure** icon.
2. Select **Lay Out**.
3. The **Point** icon will be automatically selected.

4. You can isolate points by selecting the appropriate layer under the **Layer** icon or by pressing the Point List icon in the lower left and using the Point Filter options to create a point list for your layout session.
5. Tap on the first point you need to lay out. If there are multiple points on top of one another or close together, a point selection box will appear in the lower left corner and you can select the correct point.
6. The **Direction Bar** at the top will indicate Back or Forward to the RTS, Left or Right as you are looking at the RTS, and up or down to the correct elevation. You can toggle the direction bar to give Horizontal/Vertical changes or the Back/Forward, Left/Right, Up/Down bar.

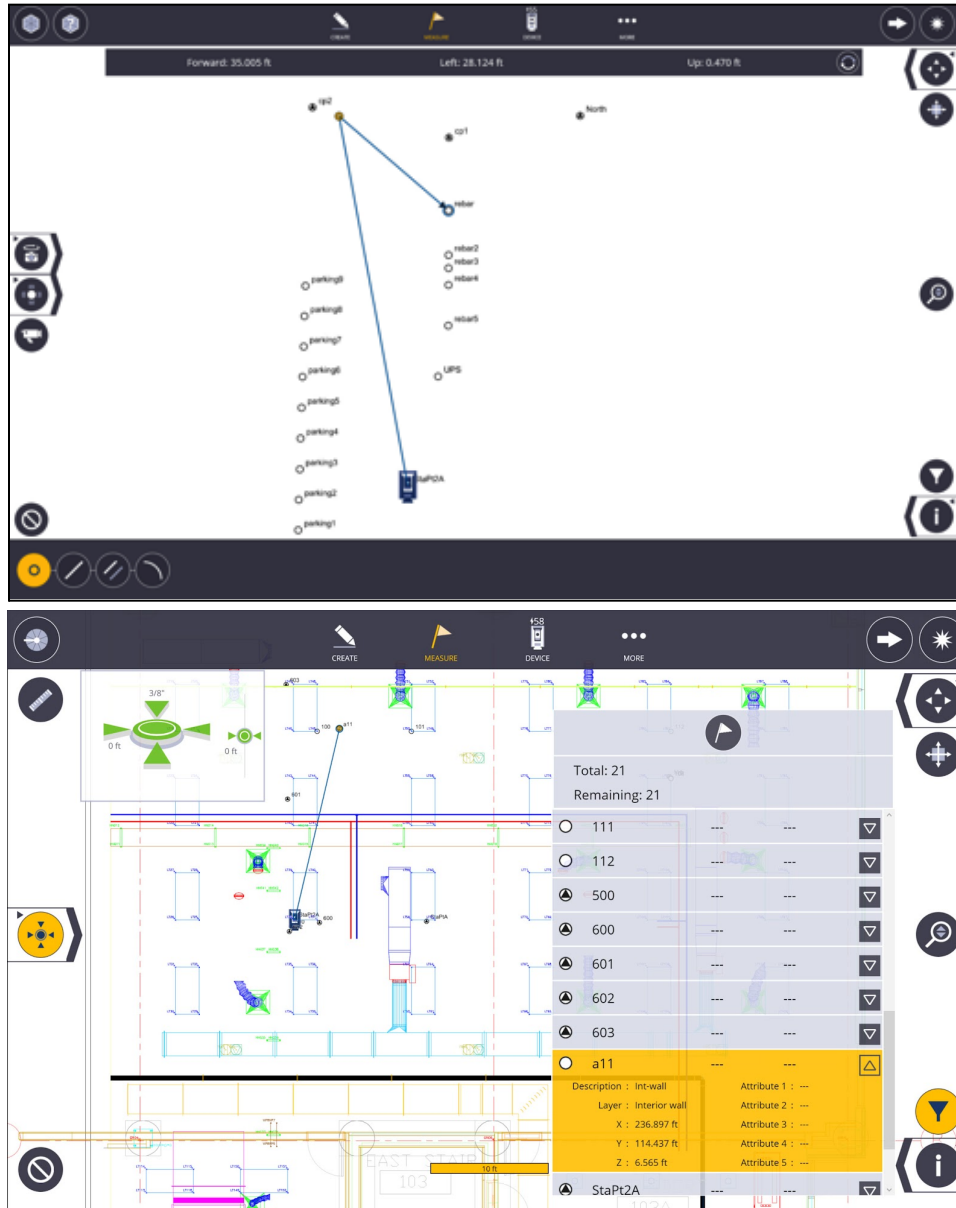

7. You also now have the option to select the **Corner Bullseye** to display on the screen under **Map Options**. If you have a point list created, you can also look at point information including position, layer and attributes for each point.

8. If you are in Laser mode, the RTS will automatically aim at the point as soon as you tap on the point. If using **Visual Layout** as checked in the Measurement Settings, the laser beam will move to the correct X, Y position and show any vertical deviation in the lower dialogue bar.
9. Once you are within approximately 3' (1 meter) from the point, the screen will automatically change to a bullseye mode. You can change back to the plan view by tapping the **Bullseye** icon.



10. If the Laser fails to measure after three attempts, but is very close, you have the option to maneuver the laser manually with the joystick features and or the nudge buttons.

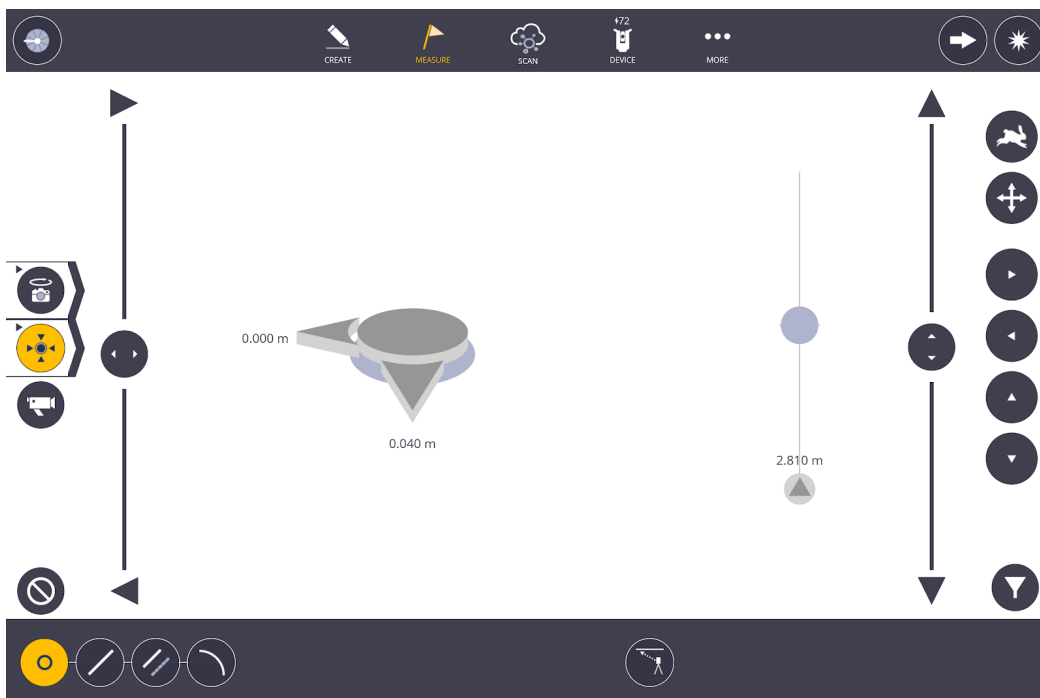

11. Tap the **Next** arrow icon to advance to the next point if you do not want to store the as-built information for future use and quality assurance.
12. Tap the **Shoot** icon to collect the as-built information and store this information for future use and quality assurance.
13. Tap the **Next** arrow icon to advance to the **Next** or **Nearest** point as selected in the Measure Settings from Section 6.1.
14. The lower Message Bar will appear giving the staked point information. Points measured within the tolerance settings will appear as green check marks. Points outside of tolerance settings will appear as red X's.

6.3.2 Point Layout List

If you have the 3D Feature Pack then you can generate a point layout list. The list can be populated by selecting individual points on the screen, multiple selections with a window or using a filter by name, description or layer. Note with 6.0 release, when using the functionality filter layer with points, only layers that include points will be visible.

To create a point lay out list:

1. Tap **Point Layout List** icon
2. **Populate list** via:
 - a. Point selection on map
 - b. Multiple selection with window selection
 - c. Tap Add icon enter by Name, Description or Layer
3. Clear list via cancel icon
4. To Layout with list, tap **Layout** icon
5. Advanced to next on list use **Arrow**

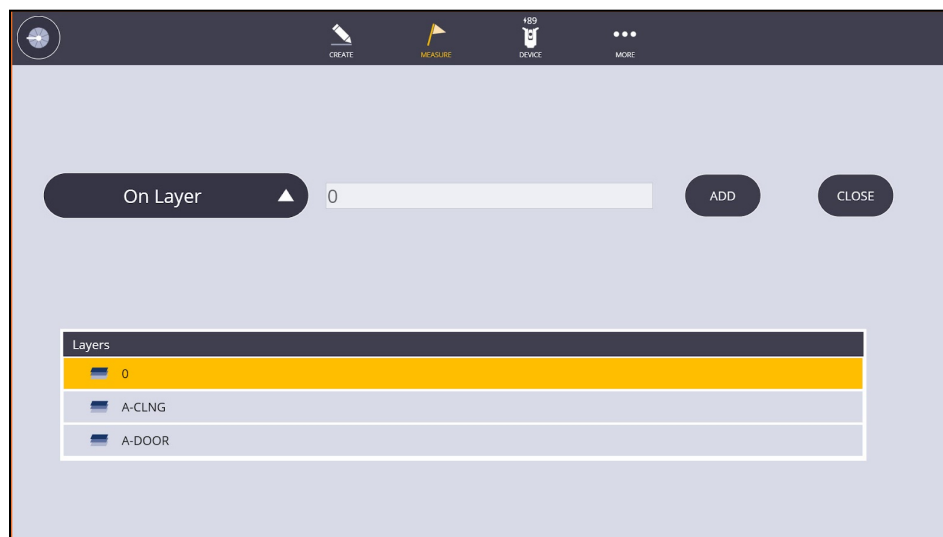



6.3.3 Point Transfer

There may be times when you can't lay out on the floor because there are obstacles in the way. This feature allows you to switch between layout on the **floor** and the **ceiling**.

1. Tap the **Measure** icon.
2. Select **Lay Out**.
3. Tap the **Transfer** icon at the lower part of the screen.

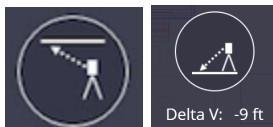

4. Follow the prompt to aim at either the floor or ceiling for a reference elevation. Then you can layout the point you want to transfer.
5. You can then keep tapping on the **Transfer** icon to switch between floor and ceiling.

6.3.4 Layout Line

FieldLink provides the ability to layout linework by selecting 2 points to define a line segment or multiple points to define a polyline. Any temporary offset or interval points created in this section will not remain in the database until they are actually measured.

1. Tap the **Measure** icon.
2. Select **Lay Out**.
3. Tap the **Line** icon at the lower left of the screen.

4. Tap the **Clear** Selection icon to select new points.
5. Tap on two points to create the blue line to be staked. You can tap on additional points to offset a polyline around a building or utility run.
6. Tap the **Input Form** to create an *Offset Distance*, *Interval Distance*, *Start Distance*, *Name*, *Description* and *Layer* of the points to be laid out along the line. You can enter "0" for the *Interval Distance* to take measurements along the line or offset line directly.
7. Tap the Input Form again to see the temporarily created points represented as open blue circles on the plan view to ensure the correct locations.
8. Tap the **Left/Right/Both Sides** icon to toggle the offset points on either or both sides of the line.
9. Tap on the first point to be measured if you entered an *Interval Distance*.
10. The **Direction Bar** at the top will indicate Back or Forward to the RTS, Left or Right as you are looking at the RTS, and up or down to the correct elevation. You can toggle the direction bar to give Down and Offset positions or the Back/Forward, Left/Right, Up/Down bar.
11. If you are in Laser mode, the RTS will automatically aim at the point as soon as you tap on the point. If using **Visual Layout** as checked in the Measurement Settings, the laser beam will move to the correct X, Y position and show any vertical deviation on the right-hand side of the screen.

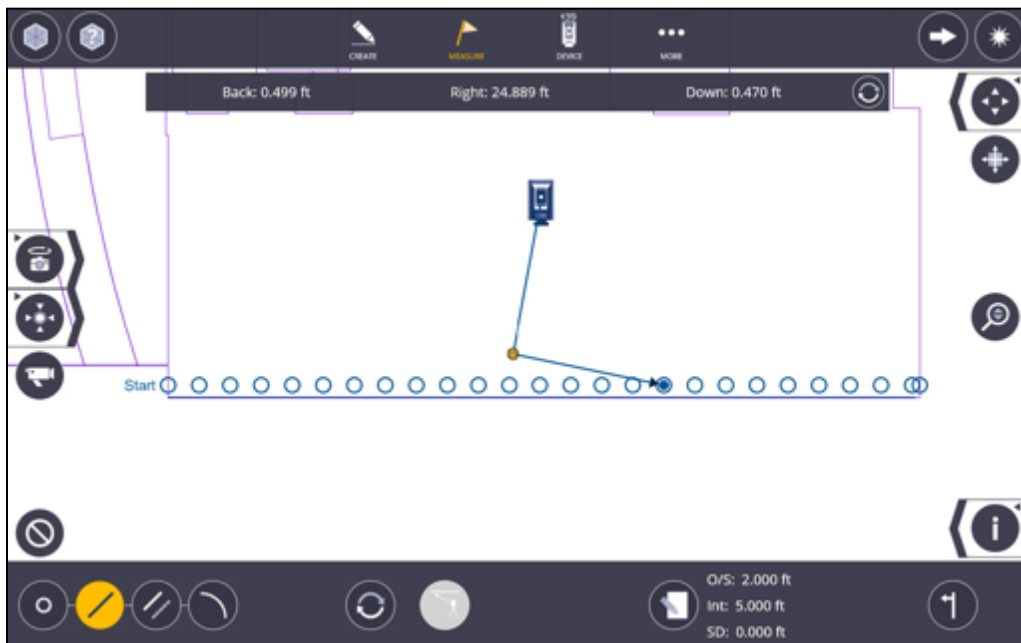

12. Once you are within approximately 3' (1 meter) from the point, the screen will automatically change to a bullseye mode. You can change back to the plan view by tapping the **Bullseye** icon.
13. Tap the **Shoot icon** to collect the as-built information and store this information for future use and quality assurance.

14. Tap the **Next** arrow icon to advance to the **Next** or **Nearest** point as selected in the Measure Settings from Section 6.1.
15. The lower Message Bar will appear giving the staked point information.

6.3.5 Layout to a Line

FieldLink provides the ability to layout linework and offset lines with Down and Out measurements by selecting only 2 points to define the line. This method is a quick and easy way to stake a continuous line anywhere on the line.

1. Tap the **Measure** icon.
2. Select **Lay Out**.
3. Tap the **Offset Line** icon at the lower left of the screen.
4. Tap the **Clear** Selection icon to select new points.
5. Tap on two points to create the blue line to be staked.
6. Tap the **Input Form** to create an *Offset Distance, Name, Description* and *Layer* of any points to be laid out along the line. You can enter "0" for the Offset Distance and take measures along the line directly.
7. Tap the Input Form again to see the temporarily created line represented as a solid blue line on the plan view to ensure the correct location.
8. Tap the **Left/Right/Both Sides** icon to toggle the offset line on either or both sides of the line.
9. The **Direction Bar** at the top will indicate Down and Offset positions. The Down dimension is from the first point you selected to create the line, the Offset distance is given as a Right or Left if you were standing at the first point you selected and are looking towards the line end point.
10. Tap the **Measure** icon to collect the as-built information and store this information for future use and quality assurance.
11. The lower Message Bar will appear giving the staked point information. Points measured within the tolerance settings will appear as green check marks. Points outside of tolerance settings will appear as red X's.

6.3.6 Layout Arc

FieldLink provides the ability to layout arcs, offset arc lines, give points at intervals along the arc or offset the interval points. You must have 2 points on the arc and input the radius length to define the arc.

1. Tap the **Measure** icon.
2. Select **Lay Out**.
3. Tap the **Arc** icon at the lower left of the screen.
4. Tap the **Clear** Selection icon to select new points.
5. Tap on two points to create the blue arc to be staked.
6. Tap the **Input Form** to create an *Offset Distance, Interval Distance, Start Distance, Radius, Name, Description* and *Layer* of any points to be laid out along the arc. You can enter "0" for the *Interval Distance* to take measures along the arc or offset arc directly.

7. Tap the Input Form again to see the temporarily created arc represented as a solid blue line on the plan view to ensure the correct location.
8. Tap on the **Short Arc/Long Arc** toggle icon to change the arc from the shortest distance along the arc to the longest distance along the arc.
9. Tap on the **Reverse Arc** icon to change the direction of the arc.
10. Tap the **Left/Right/Both Sides** icon to toggle the offset line on either or both sides of the line



11. Tap on the first point to be measured if you entered an *Interval Distance*.
12. The **Direction Bar** at the top will indicate Back or Forward to the RTS, Left or Right as you are looking at the RTS, and up or down to the correct elevation. You can toggle the direction bar to give Down and Offset positions or the Back/Forward, Left/Right, Up/Down bar.
13. If you are in Laser mode, the RTS will automatically aim at the point as soon as you tap on the point. If using **Visual Layout** as checked in the Measurement Settings, the laser beam will move to the correct X, Y position and show any vertical deviation on the right-hand side of the screen.
14. Once you are within approximately 3' (1 meter) from the point, the screen will automatically change to a bullseye mode. You can change back to the plan view by tapping the **Bullseye** icon.
15. Tap the **Shoot icon** to collect the as-built information and store this information for future use and quality assurance.
16. The lower Message Bar will appear giving the staked point information. Points measured within the tolerance settings will appear as green check marks. Points outside of tolerance settings will appear as red X's.
17. Tap the **Next** arrow icon to advance to the **Next** or **Nearest** point as selected in the Measure Settings from Section 6.1.



6.3.7 3D Perspective Model View

1. Tap **arrow** next to bullseye icon
2. Select **prism** icon
3. The **3D Perspective Model View** will be displayed, as viewed within the model showing the position of the prism on pole or Laser point if in Laser mode, the instrument location and relationship to the point being laid out.
4. Directions are displayed, view & directions will update as you move to the point selected.

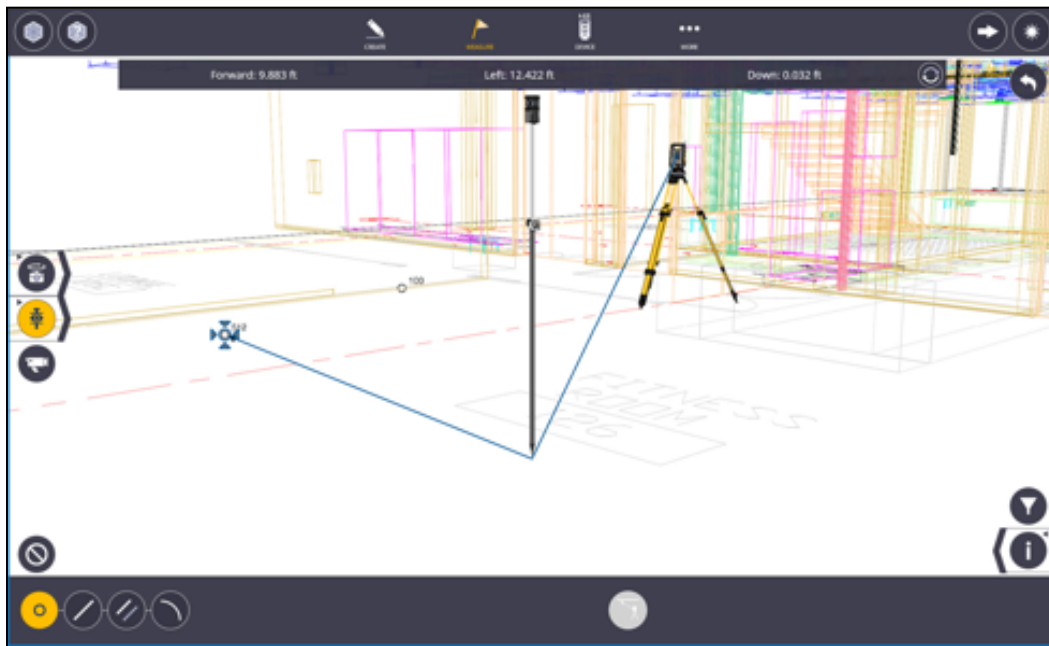

Tip



Use of Feature Codes sets such as AB for Anchor Bolts, TR for Tree, TBC for Top Back of Curb, can help the field and office team understand collected and lay out items faster and easier. Feature Codes can also help save time in the office by automatically creating drawings or 3D model information in certain software.



Important

Make sure to check your backsight or stake your control points periodically to ensure the instrument has not shifted locations due to settlement, thermal changes, or interference.

6.3.8 Create Points - Layout Line

1. Tap the **Measure** icon.
2. Select **Layout**.
3. Select two points that define the line
4. Tap the **Input/Edit** button
5. Input **Offset, Interval, Start Distance, Name, Description** and **Layer**
6. Tap **Create** to add points

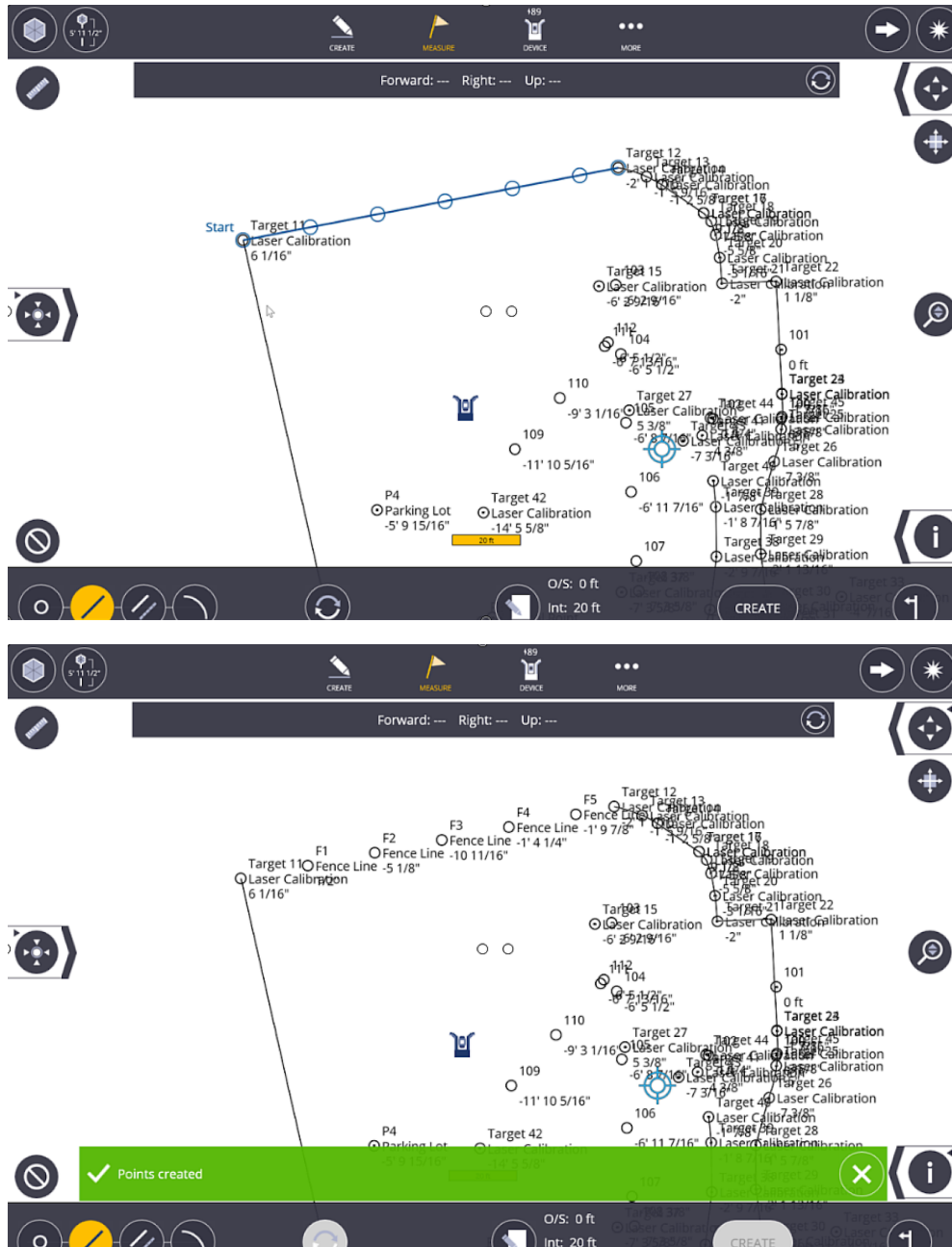

6.4 Wall Penetration

FieldLink will accurately locate wall penetrations.

1. Tap the **Measure** icon.
2. Select **Wall Penetration**.
3. Select two points that define the object to penetrate the wall
4. Tap the **Aim**.
5. The laser will point to the location on the vector between the two points that intersects the wall.
6. You can use the **Input Form** icon to define offsets for left, right, up and down.
7. You can then apply these offsets to the penetration.

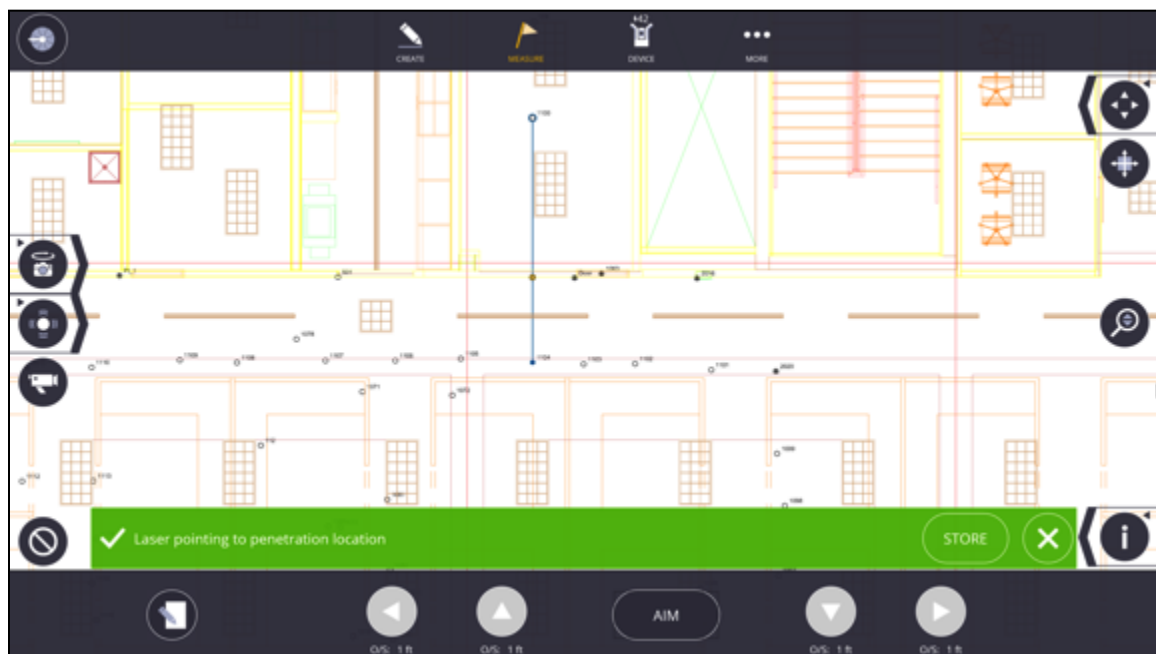

6.5 Surface (Optional Module)

FieldLink can accurately define the low and high areas of a horizontal or vertical surface whether it is the floor, ceiling or wall via the use of the Surface Module. The first step is to define and measure the surface, then, FieldLink can calculate the low and high contours based on a reference elevation and a tolerance. You are then able to layout the location of these contours. Later we will show how you can generate a report based the information collected.

Note: Only works with .xml files

6.5.1 Define and Measure the Surface Area

1. Tap the **Measure** icon.
2. Select **Surface**.
3. To **add a new surface** select the fence icon on the right of the screen
4. Select the plus icon to enter and select the details of the surface, **Name**, **Horizontal** or **Vertical** surface, and **Layer**.
5. Tap the **Close** button to return to the model view.

6. Select the **Fence** icon in the bottom to edit the boundary of the surface. If you have existing points around the edges of the surface, Grab and drag the corner manipulators to the desired location to define the boundary of the surface area. You can also define the surface by measuring new points.
7. Tap the **Fence** icon to close out of the editing boundary.

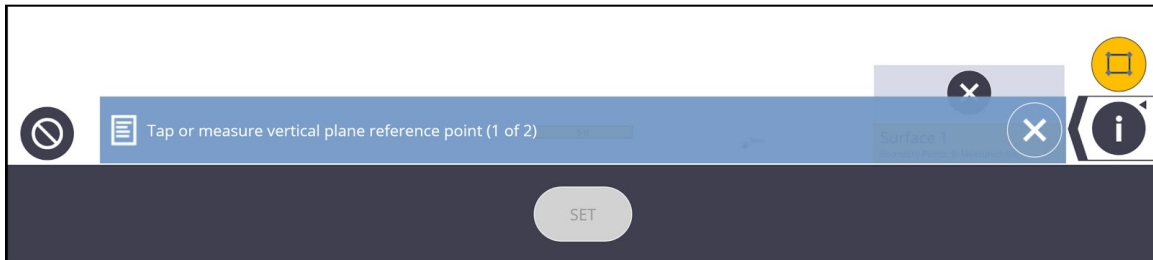

8. Tap on input form. Enter **Number of Points** or **Grid Spacing** by tapping circle icon to switch between options. Tap input form to close, the number of points will be calculated and displayed on the screen.
9. If you are using the Horizontal Surface, select **Ceiling** or **Floor**.



10. For automated Laser data collect, select the **Automatic** option
11. Tap **Start**, to capture data
12. You will be prompted to Point instrument at the surface to be measured, then tap Yes or No
13. If collecting the Floor Surface manually, walk with the prism pole and navigate to the point to start collecting data. If Automatic the instrument will use the laser mode to collect data and indicate progress.

6.5.2 Calculate High & Low Areas

1. Tap on the layout **Flag** icon
2. Tap in **Input Form**
3. Enter **Elevation** and **Tolerance**, close Input Form
4. The **High (red)**, **Low (blue)** and **In-Tolerance (green)** contours are calculated and displayed on the screen





6.5.3 Layout a Contour

1. Select a **node on the contour**
2. If in **Laser mode** tap **Aim**, the instrument will point to the location with laser pointer. If in **Prism mode**, you will receive navigation to the point.
3. Tap **Store** to record point.

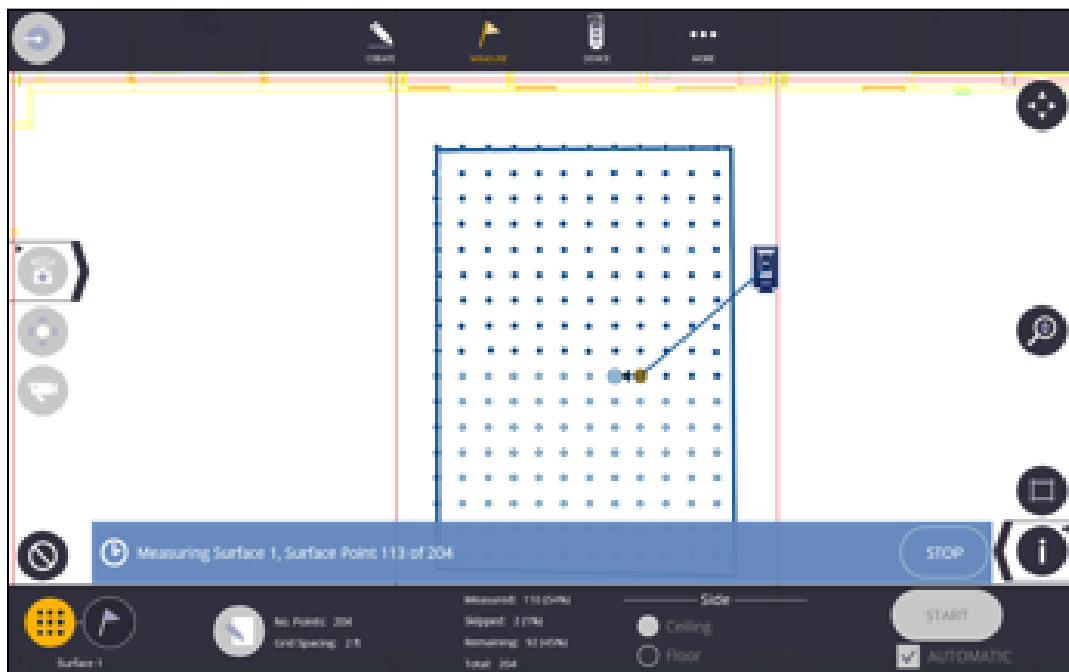

To create a **Surface Report**, go to Section 8 **Report Mode**, of this guide.

6.6 Layout Plane

Layout Plane allows the user to specify a flat plane, tilted plane, or sloping plane and can be utilized similar to a rotating or sloping line laser. The Layout Plane feature also has audible sounds to help with grading in loud environments to indicate high, low, or on-grade measurements.

6.6.1 Flat Plane

To define a flat plane, you can type in an elevation or pick a point on the screen. The user can then layout that flat plane. FieldLink will show the user if they are in tolerance, in a cut location or in a fill location. Points will be recorded on the screen green for in tolerance, red for cut and blue for fill.

1. Tap the **Measure** icon
2. Select **Lay Out Plane**
3. Either select a **point on the screen** or tap the **input form** and **type** in or **measure** an **elevation**
4. **Move** to where you want to layout
5. FieldLink will show **cut** (*high*), **fill** (*low*) or **in tolerance** (*level*)
6. Tap the **Shoot** icon to collect as-built information and store this information for future use and quality assurance.



Indicates cut (high)



Indicates fill (low)

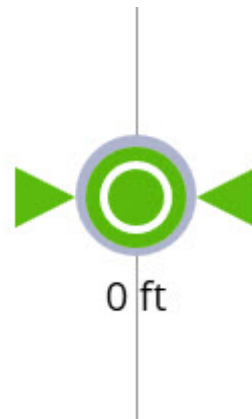

Indicates in tolerance (level)

6.6.2 Tilted Plane

To define a tilted plane, you can type select three points on the screen.

1. Tap the **Measure** icon 
2. Select **Lay Out Plane**
3. Select **3-point tilted plane** icon
4. Either **Select 3-points** on the map screen or **Measure 3 points**



5. Tap **Accept**
6. **Move** to where you want to layout
7. FieldLink will show **cut** (*high*), **fill** (*low*) or **in tolerance** (*level*)
8. Tap the **Shoot** icon to collect the as-built information and store this information for future use and quality assurance.
9. To measure a new tilted plane, tap **Configure** and repeat steps above.

6.6.3 Sloping Plane

To define a sloping plane, you can type select three points on the screen.

1. Tap the **Measure** icon 
2. Select **Lay Out Plane**
3. Select **Sloping plane** icon
4. Either **a point** on the **map** screen or **Measure a point**
5. Tap **Input Form** to enter **Direction of slope** and either **Slope percentage (%)** or **Rise/Run** or **Run/Rise**

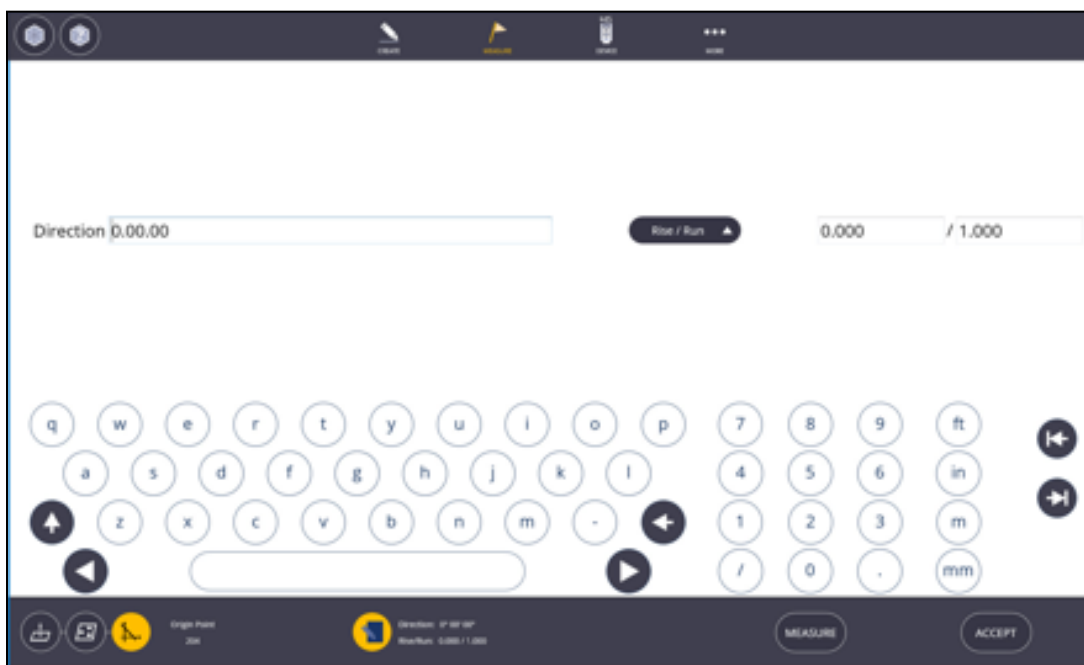

6. **Move** to where you want to layout
7. FieldLink will show **cut** (*high*), **fill** (*low*) or **in tolerance** (*level*)
8. Tap the **Shoot** icon to collect the as-built information and store this information for future use and quality assurance.
9. To measure a new tilted plane, tap **Configure** and repeat steps above.

7. Reports Mode

7.1 Layout Deviation Report

The Layout Deviation report allows you to create spreadsheet style layout data for the entire project. The data will show the project information, point information, and delta values (in XYZ and NEZ), for points that were laid out in the range of dates defined in a .csv format.

1. Tap on the **More** icon.
2. Select **Reports** and then **Layout Deviation Report**.
3. A preview of the report will automatically be shown on the screen.
4. Tap on one of the column headers to sort by Point Name, Description, Layer, Northing (Y), Easting (X), Elevation (Z), or by Delta's. Tap again to sort by ascending or descending order.
5. Tap on the **Input Form** icon to designate where you want the report saved.

Point Name	Description	Layer	Northing (Y)	Easting (X)	Elevation (Z)	Delta H	Delta N (Y)	Delta E (X)	Delta V (Z)
501		control	-13.041 ft	3.637 ft	137.000 ft	0.021 ft	0.019 ft	-0.010 ft	0.004 ft
1076	floor	A-FLOR	-50.062 ft	5.659 ft	127.602 ft	0.039 ft	-0.038 ft	-0.008 ft	0.316 ft
1081	floor	A-FLOR	-26.690 ft	6.667 ft	127.927 ft	0.036 ft	0.020 ft	-0.030 ft	-0.002 ft
1082	floor	A-FLOR	-31.030 ft	6.841 ft	127.904 ft	0.026 ft	0.007 ft	-0.026 ft	-0.032 ft
1083	floor	0	-35.256 ft	7.028 ft	127.887 ft	0.519 ft	0.474 ft	0.210 ft	0.343 ft
1084	floor	A-FLOR	-39.760 ft	5.318 ft	127.887 ft	0.003 ft	0.003 ft	0.001 ft	0.035 ft
1085	floor	A-FLOR	-44.646 ft	3.776 ft	127.890 ft	0.007 ft	0.003 ft	-0.006 ft	-0.002 ft
1086	floor	A-FLOR	-49.160 ft	5.620 ft	127.913 ft	0.033 ft	0.012 ft	0.030 ft	-0.001 ft
1087	floor	A-FLOR	-52.677 ft	8.373 ft	127.949 ft	0.019 ft	-0.006 ft	-0.018 ft	0.000 ft
1088	floor	0	-54.327 ft	14.997 ft	127.979 ft	0.016 ft	-0.006 ft	0.015 ft	0.002 ft
1089	floor	0	-54.426 ft	19.403 ft	127.976 ft	0.026 ft	-0.023 ft	-0.013 ft	-0.001 ft
1090	floor	0	-52.562 ft	28.763 ft	127.966 ft	0.024 ft	0.022 ft	-0.009 ft	0.002 ft
1091	floor	0	-47.749 ft	28.957 ft	127.953 ft	0.018 ft	-0.014 ft	-0.012 ft	0.000 ft
1092	floor	0	-43.366 ft	29.035 ft	127.933 ft	0.017 ft	-0.005 ft	0.016 ft	0.001 ft
1093	floor	0	-39.757 ft	29.052 ft	127.940 ft	0.002 ft	0.000 ft	0.002 ft	0.002 ft
1094	floor	0	-36.795 ft	29.032 ft	127.953 ft	0.034 ft	-0.033 ft	-0.008 ft	-0.001 ft
1095	floor	0	-34.213 ft	26.204 ft	127.940 ft	0.023 ft	0.003 ft	-0.022 ft	0.001 ft

6. The report default saved location is under **C:\Users\xxxx\Documents\FieldLink\Reports\ Layout Deviation Reports** folder.
7. Tap on the **Layer** icon to save the report to your computer, a USB drive, or Trimble Connect. You will need to disconnect from the RTS and sign into Trimble Connect for it to be an option. The USB option is only available when a USB memory device is plugged into the computer.
8. Tap the **Save** icon.

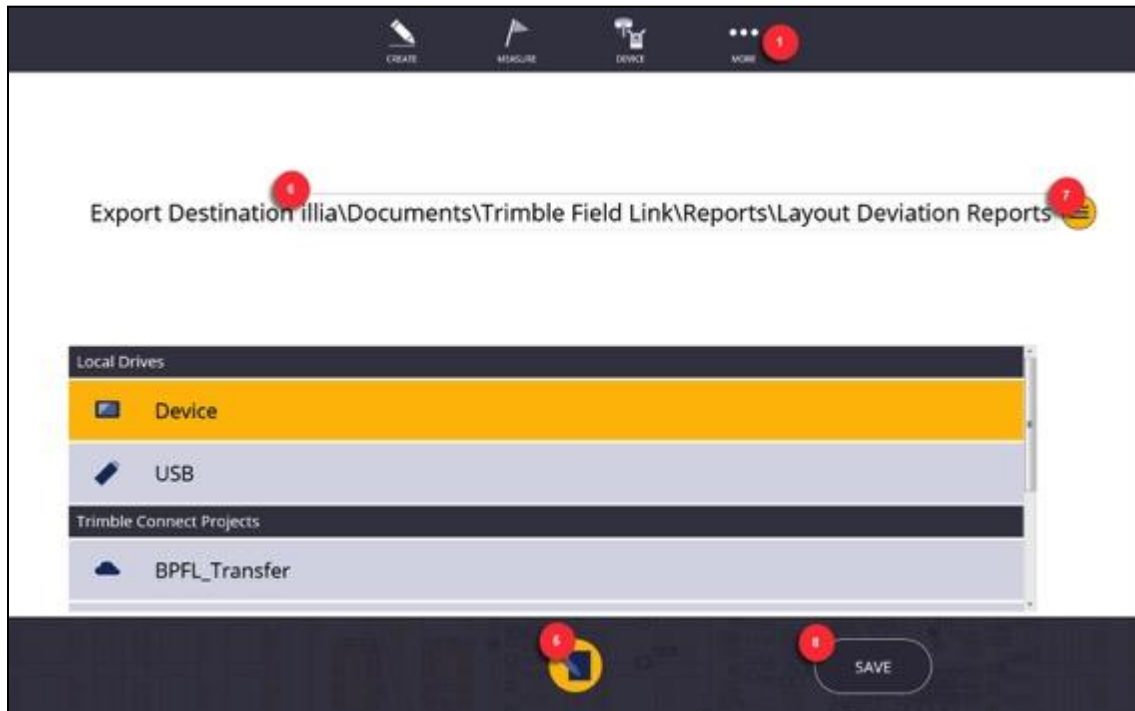

	A	B	C	D	E	F	G	H	I	J	K
1	Trimble Field Link										
2	Layout Deviation Report										
3	TFL_TRMB_LEVEL3_b										
4	Friday	October 30	2015								
5	3:27:25 PM										
6											
7											
8											
9	Point Name	Description	Layer	Northing	Easting (X	Elevation	Delta H	Delta N (Y	Delta E (X	Delta V (Z)	
10	1076	door	0	-15.259 m	1.725 m	38.893 m	0.012 m	-0.012 m	-0.003 m	0.097 m	
11	1081	door	0	-8.135 m	2.032 m	38.992 m	0.011 m	0.006 m	-0.009 m	-0.001 m	
12	1082	door	0	-9.458 m	2.085 m	38.985 m	0.005 m	0.000 m	-0.005 m	-0.001 m	
13	1083	door	0	-10.746 m	2.142 m	38.980 m	0.158 m	0.145 m	0.064 m	0.105 m	
14	1084	door	0	-12.119 m	1.621 m	38.980 m	0.001 m	0.001 m	0.000 m	0.011 m	
15	1085	door	0	-13.608 m	1.151 m	38.981 m	0.002 m	0.001 m	-0.002 m	-0.001 m	
16	1086	door	0	-14.984 m	1.713 m	38.988 m	0.010 m	0.004 m	0.009 m	0.000 m	
17	1087	door	0	-16.056 m	2.552 m	38.999 m	0.006 m	-0.002 m	-0.005 m	0.000 m	
18	1088	door	0	-16.559 m	4.571 m	39.008 m	0.005 m	-0.002 m	0.005 m	0.001 m	
19	1089	door	0	-16.589 m	5.914 m	39.007 m	0.008 m	-0.007 m	-0.004 m	0.000 m	
20	1090	door	0	-16.021 m	8.767 m	39.004 m	0.007 m	0.007 m	-0.003 m	0.001 m	
21	1091	door	0	-14.554 m	8.826 m	39.000 m	0.006 m	-0.004 m	-0.004 m	0.000 m	
22	1092	door	0	-13.218 m	8.850 m	38.994 m	0.005 m	-0.002 m	0.005 m	0.000 m	

7.2 Daily Layout Summary

To create a Daily Layout Summary report.

1. Tap **More** icon, then **Reports**
2. Select **Daily Layout Summary**
3. Select **Date**, **Destination**, enter **Notes**
4. Tap **Preview**
5. Tap **Save**, the report is saved as a PDF in documents/FieldLink /Reports folder

Trimble® Field Link

Daily Layout Summary

Date Report Created	Thursday, May 25, 2017
Time	3:27:36 PM
Date of Layout	Monday, March 21, 2016
Job Name	WCO_GNSS_2

Layout Session 1

Setup 1	Setup Time: 3/21/2016 12:08:32 PM			Setup Type: Anywhere	
Instrument Location: N: 1205816.068 ft, E: 3108843.690 ft, Z: 5467.676 ft				Instrument Position Within: 0.000 ft	
Control Point	N:	E:	Z:	Quality	Distance from Instrument
101	N: 1205874.586 ft	E: 3108902.208 ft	Z: 5466.130 ft	Excellent	82.756 ft
100	N: 1205874.586 ft	E: 3108785.173 ft	Z: 5469.220 ft	Excellent	82.756 ft

First Point Laid Out	133, 12:12 PM
Last Point Laid Out	145, 12:57 PM
Number of Points Laid Out	13
Layout Time	0 hours, 45 minutes
Points Per Hour (Average)	17

PREVIEW
SAVE

7.3 Field Report

To Create a Field Report

1. Tap **More** icon, then **Reports**
2. Select **Field Report**
3. Select/Enter **Name, Destination, Notes**, capture **Pictures**, and measure **Location** (pictures can be collected via tablet or RTS)
4. Tap **Preview**
5. Tap **Save** the report is saved as a PDF in documents/FieldLink /Reports folder



7.4 Surface Report

To Create a Field Report

1. Tap **More** icon, then **Reports**.
2. Select **Surface Report**.
3. To select the surface tap **Fence** icon.
4. Select Surface either by tap on the display or by name in bottom right of the screen.
5. Tap **Fence** icon to close selection.
6. Tap **Input Form**.
7. Enter Report **Name** and select the location to save the report.
8. Tap **Preview**.
9. Check the **CSV Export** box to also export the collected points list.
10. Tap **Save**.

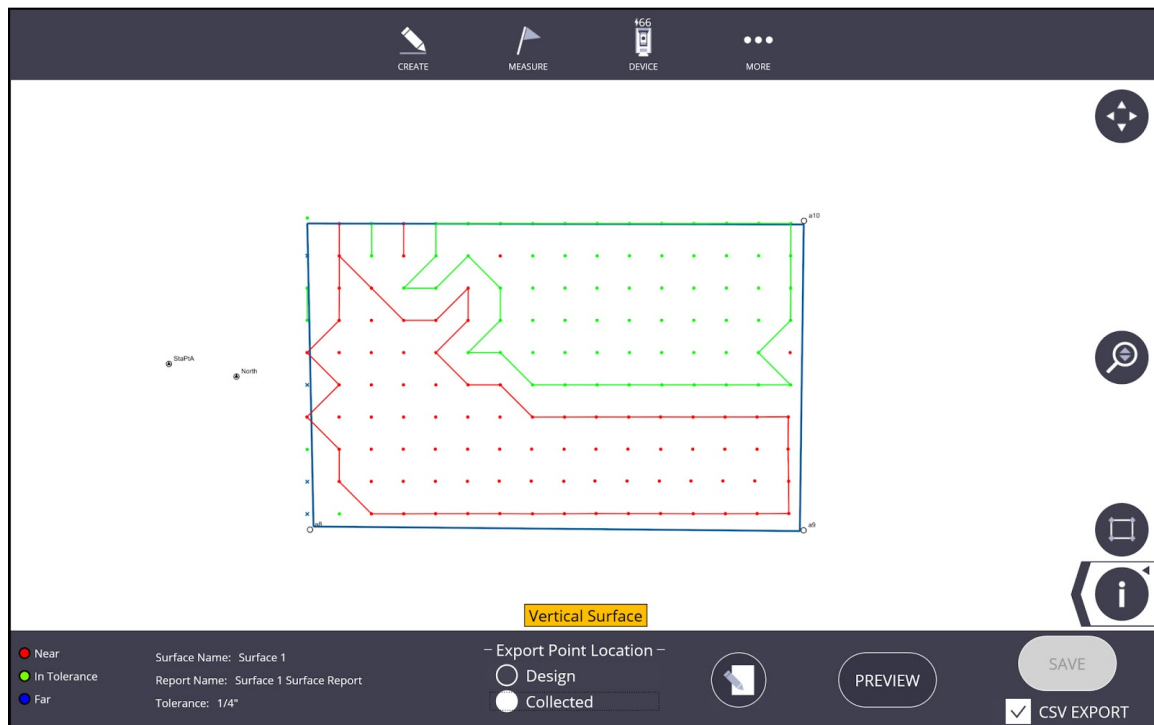

Trimble® Field Link

Surface Report

Date	Thursday, June 7, 2018
Time	3:01:29 PM
Trimble Field Link Job	Test12

Total Points	160
Near Points	85 (53%)
In Tolerance Points	71 (44%)
Far Points	0 (0%)

Elevation	N/A
Tolerance	1/4"
Highest Deviation	1.3/8"
Median Deviation	1/4"
Lowest Deviation	-1/8"

Near Contours	4
Total Near Area	0.025 ft ²
Total Near Volume	0.000 yds ³
In Tolerance Contours	6
Total In Tolerance Area	0.016 ft ²
Far Contours	0
Total Far Area	0.000 ft ²
Total Far Volume	0.000 yds ³

● Near Surface Name: Surface 1 - Export Point Location -
● In Tolerance Report Name: Surface 1 Surface Report Design
● Far Tolerance: 1/4" Collected

 CSV EXPORT

```

Surface 1_20180607_150233.csv - Notepad
File Edit Format View Help
NAME,X( ft ),Y( ft ),Z( ft ),DESC,LAYER,ATTRIBUTE1 NAME,ATTRIBUTE1 VALUE
Surface 1_0,351.652,368.663,7.615,Not staked,0,SurfacePointTolStatus,In tolerance
Surface 1_1,351.617,368.168,7.526,Not staked,0,SurfacePointTolStatus,High
Surface 1_2,351.622,367.667,7.527,Not staked,0,SurfacePointTolStatus,In tolerance
Surface 1_3,351.614,367.169,7.527,Not staked,0,SurfacePointTolStatus,High
Surface 1_4,351.618,366.668,7.527,Not staked,0,SurfacePointTolStatus,In tolerance
Surface 1_5,351.613,366.170,7.527,Not staked,0,SurfacePointTolStatus,In tolerance
Surface 1_6,351.619,365.667,7.528,Not staked,0,SurfacePointTolStatus,In tolerance
Surface 1_7,351.615,365.168,7.528,Not staked,0,SurfacePointTolStatus,In tolerance
Surface 1_8,351.616,364.667,7.529,Not staked,0,SurfacePointTolStatus,In tolerance
Surface 1_9,351.612,364.168,7.528,Not staked,0,SurfacePointTolStatus,In tolerance
Surface 1_10,351.609,363.669,7.528,Not staked,0,SurfacePointTolStatus,In tolerance
Surface 1_11,351.608,363.169,7.528,Not staked,0,SurfacePointTolStatus,In tolerance
Surface 1_12,351.605,362.669,7.528,Not staked,0,SurfacePointTolStatus,In tolerance
Surface 1_13,351.617,362.162,7.530,Not staked,0,SurfacePointTolStatus,In tolerance
Surface 1_14,351.611,361.664,7.530,Not staked,0,SurfacePointTolStatus,In tolerance
Surface 1_15,351.603,361.167,7.529,Not staked,0,SurfacePointTolStatus,In tolerance
Surface 1_16,351.600,361.169,7.029,Not staked,0,SurfacePointTolStatus,In tolerance
Surface 1_17,351.607,361.666,7.029,Not staked,0,SurfacePointTolStatus,In tolerance
Surface 1_18,351.614,362.163,7.030,Not staked,0,SurfacePointTolStatus,In tolerance
Surface 1_19,351.605,362.669,7.029,Not staked,0,SurfacePointTolStatus,In tolerance
Surface 1_20,351.613,363.166,7.029,Not staked,0,SurfacePointTolStatus,In tolerance
Surface 1_21,351.610,363.668,7.029,Not staked,0,SurfacePointTolStatus,In tolerance
Surface 1_22,351.609,364.170,7.028,Not staked,0,SurfacePointTolStatus,In tolerance
Surface 1_23,351.621,364.665,7.029,Not staked,0,SurfacePointTolStatus,In tolerance
Surface 1_24,351.617,365.168,7.029,Not staked,0,SurfacePointTolStatus,In tolerance
Surface 1_25,351.605,365.672,7.027,Not staked,0,SurfacePointTolStatus,High
Surface 1_26,351.615,366.169,7.028,Not staked,0,SurfacePointTolStatus,In tolerance
Surface 1_27,351.619,366.668,7.028,Not staked,0,SurfacePointTolStatus,In tolerance
Surface 1_28,351.613,367.169,7.027,Not staked,0,SurfacePointTolStatus,High
Surface 1_29,351.625,367.667,7.028,Not staked,0,SurfacePointTolStatus,In tolerance
  
```

8. Project Management Module - Status Sharing

8.1 Status Sharing for Trimble Connect or Tekla Structures

FieldLink now offers the ability to download and upload status of model components with Trimble Connect Desktop and/or Tekla Structures. Currently, to access the Trimble Status Sharing applications for Trimble Connect Desktop or Tekla Structures, you will need to download the application from the Tekla Warehouse. If using the Status Tool with Trimble Connect Desktop, you will need to have a Pro-license of Trimble Connect and/or have an active subscription to Tekla Structures.

1. Go to Warehouse.Tekla.com and search for "Workflow Tools" and select the optional download for *Workflow Tools for Trimble Connect Desktop* and/or *Workflow Tools for Tekla Structures*.
2. Select the appropriate application and install the executable file with Trimble Connect Desktop or Tekla Structures.
3. Once installed, the Status Sharing Tool for Tekla Structures can launch from within Tekla Structures.

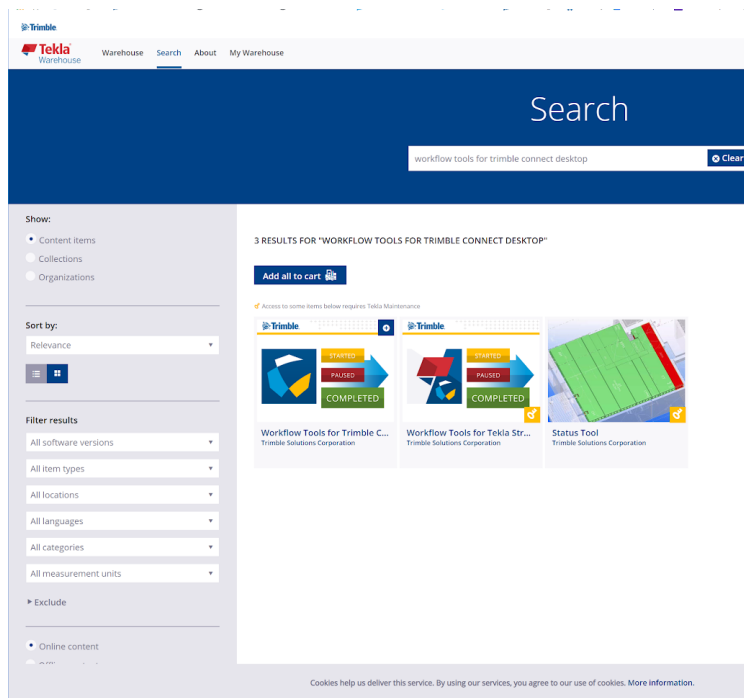

4. Open Trimble Connect Desktop, select your project and the appropriate models and then launch the *Status Sharing Application*.
5. In the Status Sharing Application, click the drop down on the left side and select "*Create new status action*", give your status a Name, select the Status's you want to include, and Create.
6. Select the correct Date in the lower center area, then select the model components in Trimble Connect Desktop view, and finally select on the

appropriate status for the components. Select a new date prior to changing status for additional model components.

7. You can reset the entire model to the original status by pressing the Reset button, or change individual components status with the date and status buttons.
8. Change the date in the upper left corner and press the play button to show the sequence of component status by date.

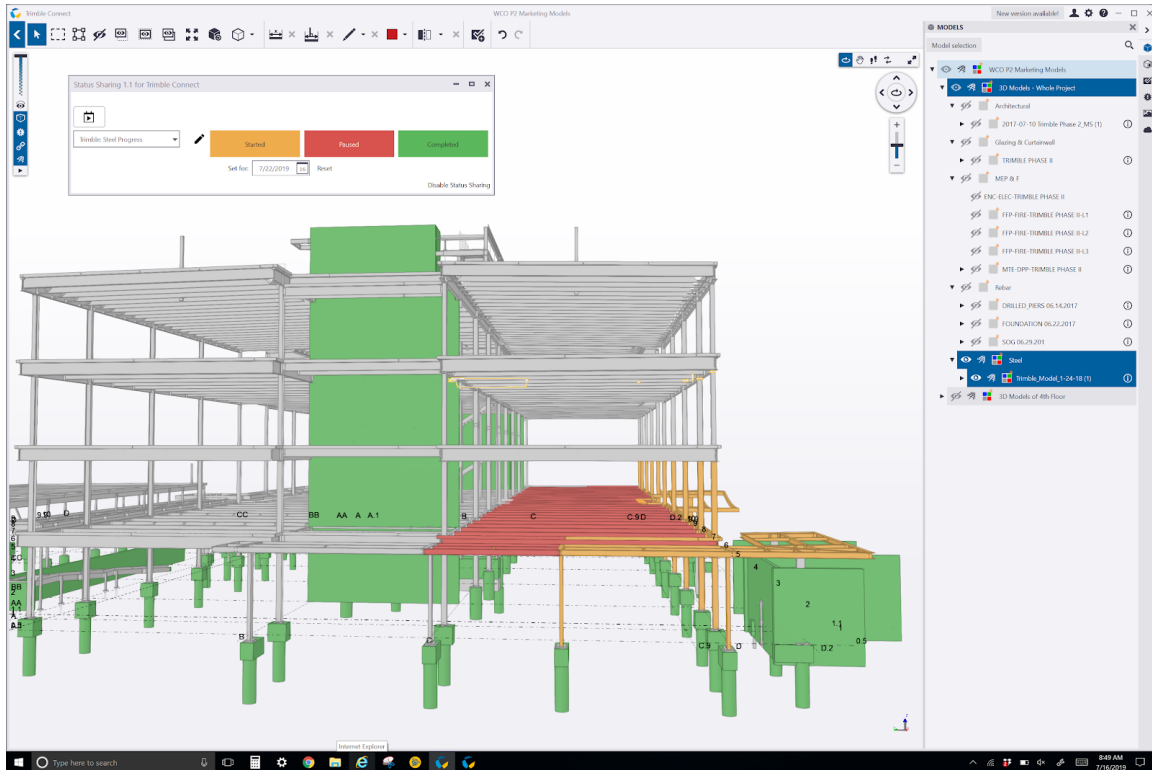

8.2 Status Sharing for FieldLink

FieldLink now offers the ability to download and upload status of model components with Trimble Connect Desktop and/or Tekla Structures. Currently, to access the Trimble Status Sharing application for FieldLink, you will need to order the Project Management Module through your BuildingPoint or Trimble representative.

1. In FieldLink, go to **More**, then **Trimble Connect**, then press the **Status Sharing** button. Make sure you have the correct model imported from Trimble Connect or already open in FieldLink.
2. Press on the Cloud icon in the lower right corner to select the correct project from Connect and any previously created Status Action names should be displayed below.
3. Once a **Status Action** has been selected, you will have options to Update, Add New, Edit, or Delete the Status Action. If no previous **Status Action** is available, you can create a New status.
4. Press on the Cloud icon again to retrieve the status colorization that were already created in previous **Status Action**.

- Once the status colorizations have been downloaded or a new Status Action has been created, you can then add or edit status colorizations and dates for individual model components.
- Press the Sync button to make the FieldLink Status Actions available for viewing or editing in Trimble Connect Desktop or Tekla Structures.

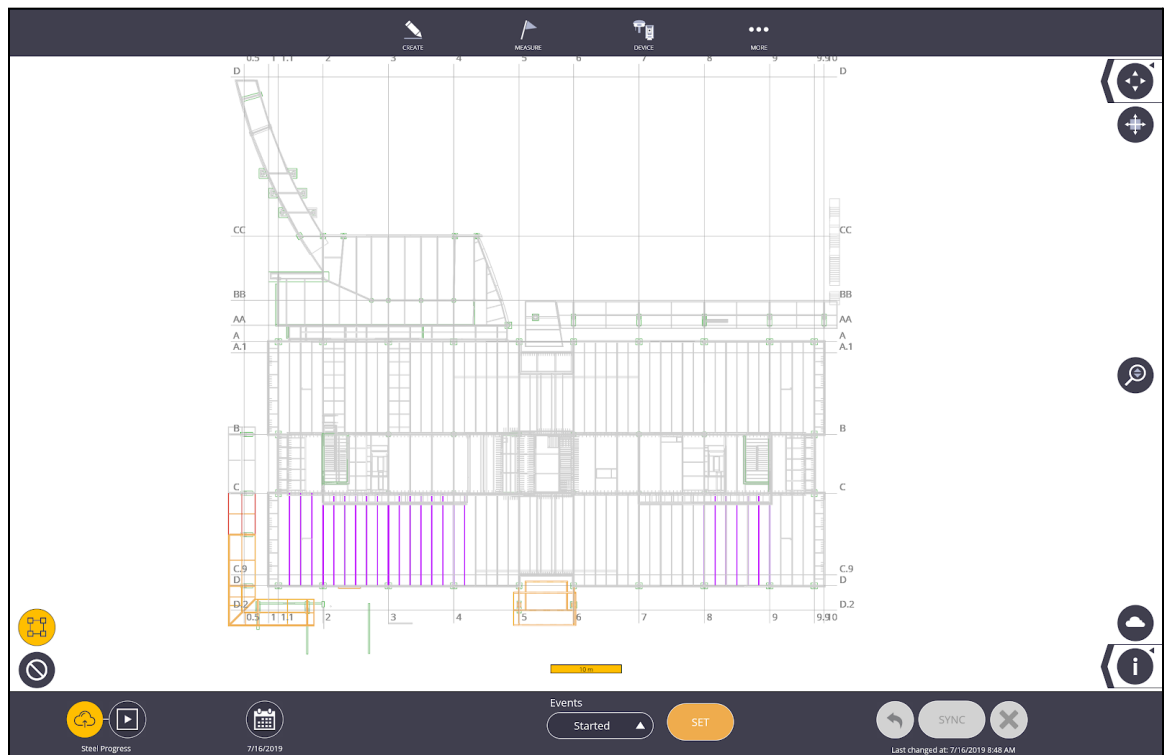
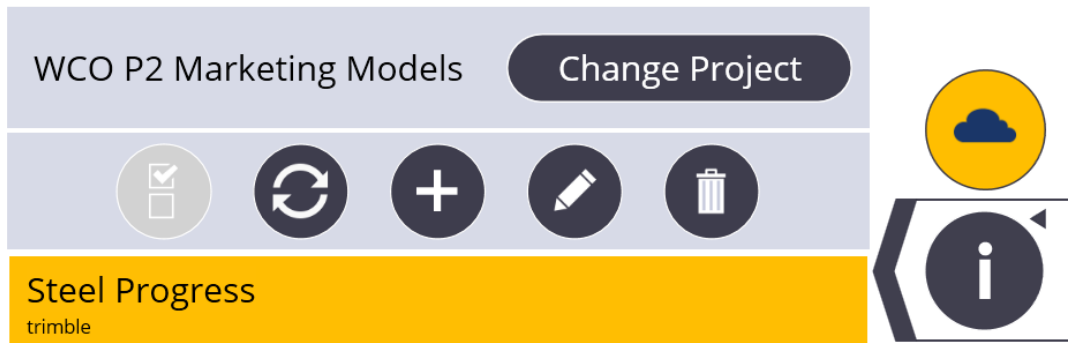
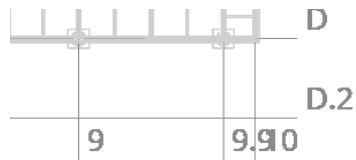

9. Scanning Module

FieldLink now offers the ability to connect to the new X7 3D laser scanner directly and collect point clouds within FieldLink. This module allows you to combine point clouds with TFL projects, overlay on 3D models and PDF's, register and refine scans, and the ability to view your 3D scans immediately after scanning. The following Work Mode Icons will only be visible if the user has purchased the FieldLink Scan Module. These Scan Module icons will modify some existing Work Modes or be entirely new icons as shown below.

Important



It is recommended that that amount of visible scans on any one project should be limited to 50 scans. The amount of visible scans can be changed using the station manager and pressing the eye button for individual or groups of scans.



9.1 Connect to the X7 Scan Device

FieldLink allows you to connect to several different types of instruments. Make sure you are connected to the X7 by executing the following procedure:

1. Tap the **Device** icon.
2. Select **Connection**. The connection window will automatically open.
3. Place the battery into the X7 with the battery indicator up and the charging ports facing the inside of the X7.
4. Press the power button on the X7.
5. Wait until the lights flash green and then tap the X7 device icon in the



Connection menu.

6. Select the Wi-Fi or cable connection option.
7. If the Wi-Fi option is selected, a list of available X7 Wi-Fi networks available will be shown. Make sure you have disconnected from any other Wi-Fi networks. Tap on the correct X7 device (ex. TRIMBLE-X7-XXXXX). If you do not see your device listed, tap the **Find** button.
8. Tap **Connect** on the correct device.
9. Once the layout or collection process is complete and you wish to disconnect from the instrument, tap the **Disconnect** icon in the Connection window before turning off the X7. Tapping the **Disconnect** icon will help ensure a proper shutdown and later reconnection.
10. Remove the X7 battery. Though it is not required, it is best practice to store the X7 with the battery out of the instrument for storage and shipping.

9.2 Establish X7 Device Location

Prior to taking any laser scans, you can shoot 2 known points from your PDF, plan or model to place the X7 scanner at the correct location on the project. If you do not have a PDF, plan or model, you can also orientate the instrument to it's true North direction, or an arbitrary plan North towards the top of the screen.

9.2.1 Plan North Set Up



Note

You must not have a model or PDF loaded into your project to do a plan North set up

To perform a plan North set up:

1. Tap the **Device** icon.
2. Select **Set Up**. If this is your first set up, the instrument will rotate to automatically calibrate itself for level measurements.
3. Select the **Aim Instrument North** icon on the bottom left hand side of the



screen. The visible laser will turn on and level out at 90 degrees.

4. Aim the X7 using the joysticks in the North direction (either plan North or the actual direction North).
5. Once the instrument is pointing in the right direction, tap **Set**. You will now be able to see which direction the laser is pointed and now when you collect scans, the instrument will know its location based on the direction it was facing during set up.

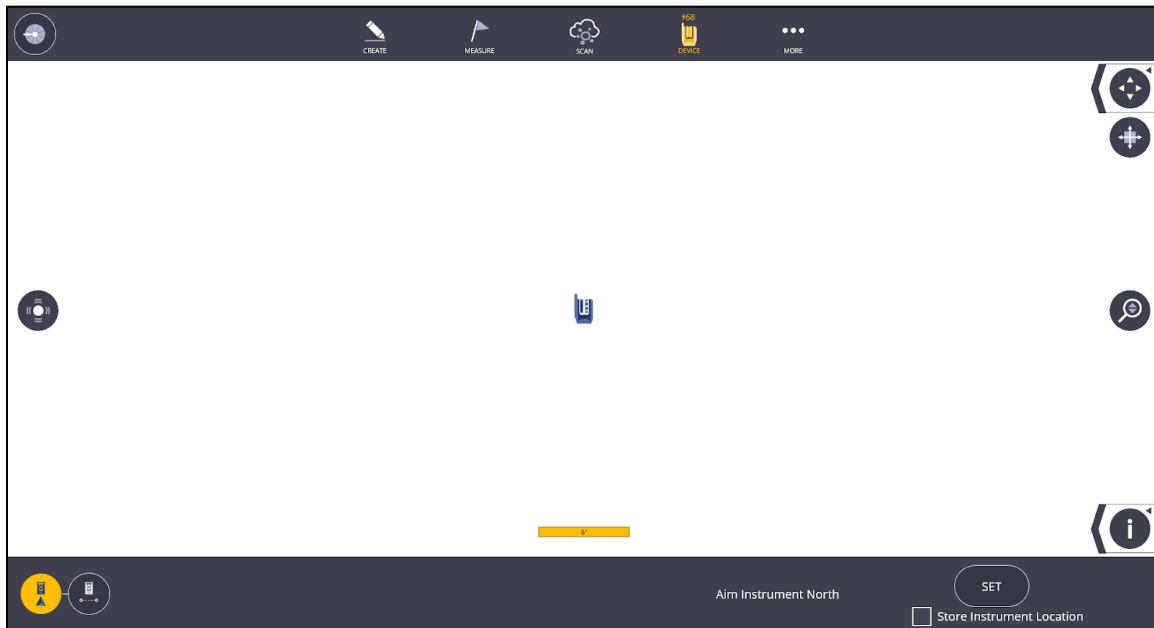

9.2.2 No Data Set Up

The second form of set-up without any data, uses a North and a Base control point for set up. You may want to use this setup method to create control points on a new project that you can tie into later. To complete the No Data Set Up:

1. Tap **Device** and select **Set Up**. If this is your first set up, the instrument will rotate to automatically calibrate itself for level measurements.



2. Tap the **North and Base Coordinate** set up icon
3. Ensure that the X7's laser pointer is on and use the joystick to point the laser to your desired North and Base targets (be sure to use the 45 to 135-degree triangle rule for these targets). If the instrument's laser pointer is not on, tap



- the laser icon at the top of the left hand side of the screen.
4. Tap the **Shoot** icon in the upper right corner of the screen to capture each point.
5. Tap on the points you have collected and choose which will be the North and which is the Base. A blue circle will appear around the point when the point has been selected. You can rotate the screen to place the points orientated for plan North similar to section 5.7.1.
6. Tap the **Set** button. You should now see both coordinates in the **Map** view.

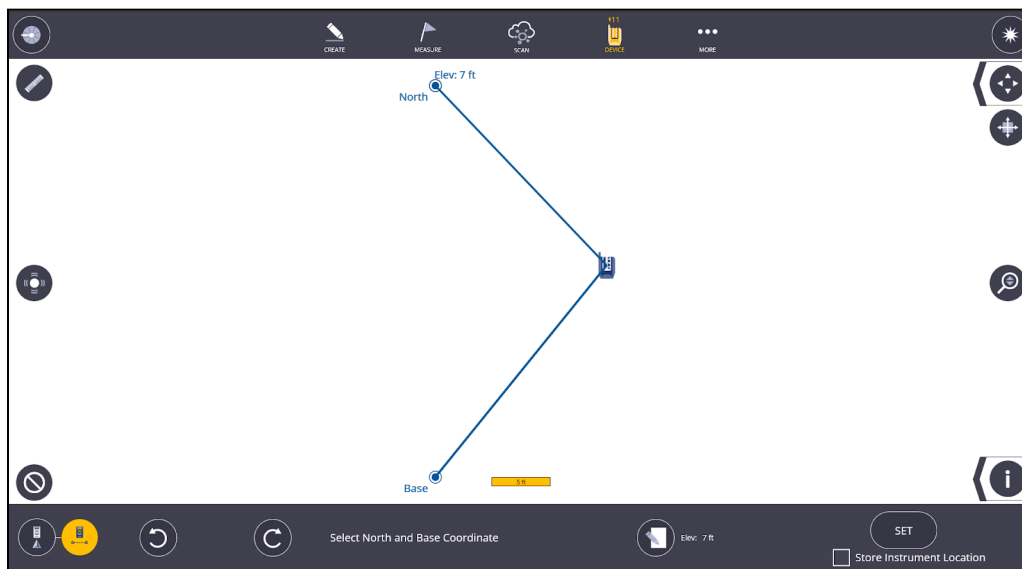
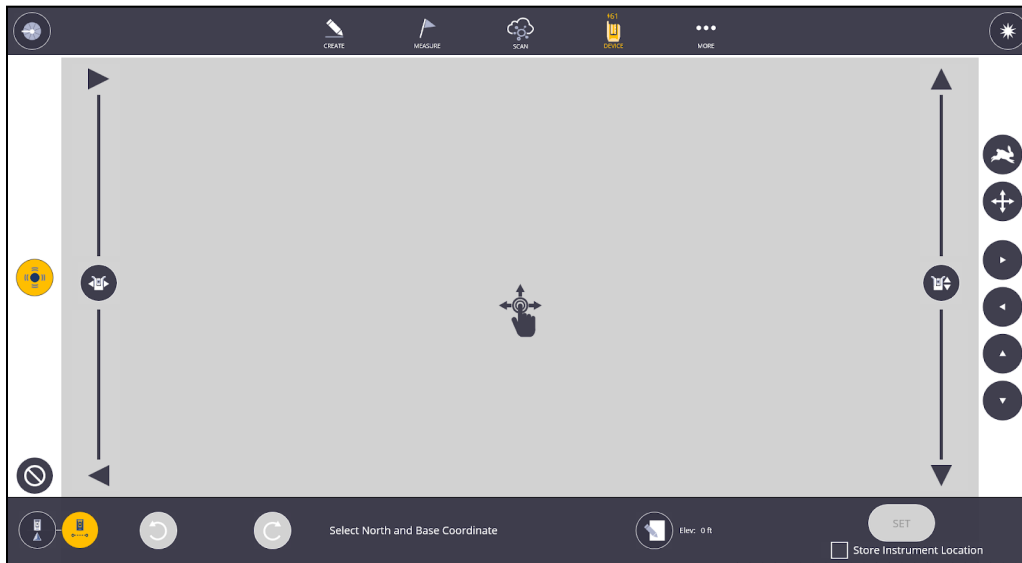

9.2.3 Background Plan or Model Set Up

1. Tap the **Device** icon and select **Set Up**. If this is your first set up, the instrument will rotate to automatically calibrate itself for level measurements.
2. If you have a PDF plan, model or drawing, tap on the first control point to be measured so it is highlighted with a blue circle on the screen.
3. Rotate the laser pointer on the X7 to point at the correct control point location using the joystick control screen.

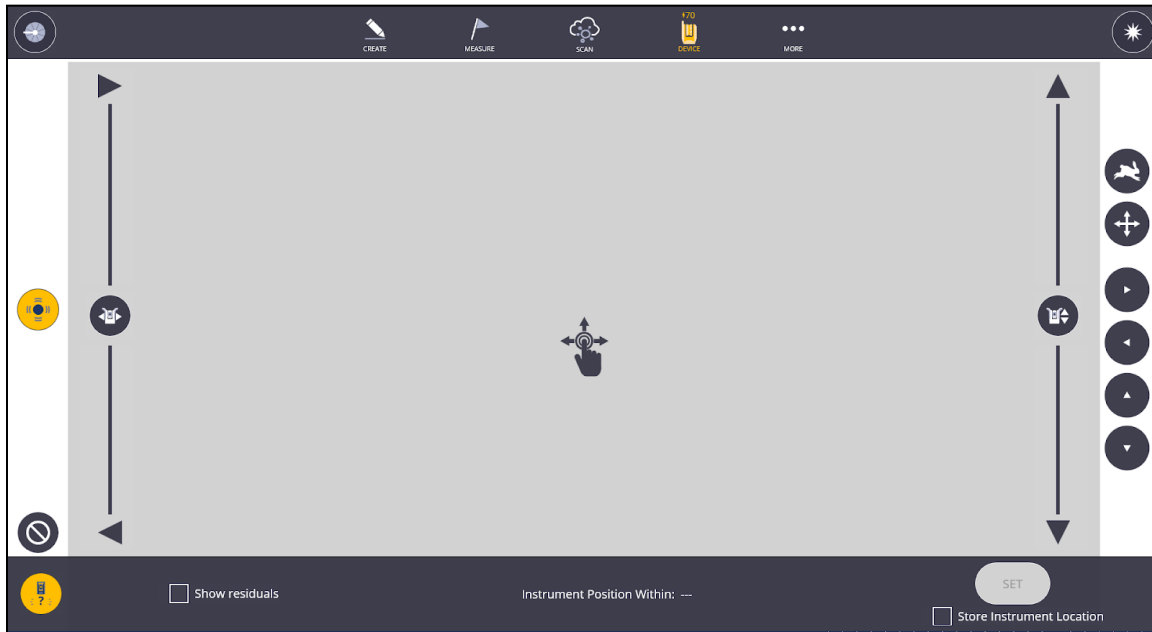

4. Tap the **Shoot** icon in the upper right corner.
5. Once the point has been measured, it will appear as a solid blue circle on the screen.
6. Tap on the second control point to be measured so it is highlighted with a blue circle on the screen.
7. Rotate the laser pointer on the X7 to point at the correct second control point location using the joystick control screen.
8. Tap the **Shoot** icon in the upper right corner.
9. If the two points are within the 45 to 135-degree triangle, the **Instrument Position Within** calculation will show a measurement of accuracy for placement within your project.
10. If the two points are under 45 degrees or outside 135 degrees apart, the program will label the set up as "Unreliable". You can tap the **Set** icon to accept this setup or recheck and re-measure the control points.
11. You can reshoot each point at any time by tapping on the measured point and tapping the **Shoot** icon.
12. Tap **Set** once you are satisfied with your location results.
13. Tap the **Clear** icon in the lower left corner to clear all measurements and start over.

9.2.4 Component Based Set Up

See section 5.7.7

9.3 X7 Scan Settings

9.3.1 Scan Settings

Prior to taking any laser scans, ensure the X7 is using the correct settings for the type of scan you wish to capture. You have the option to choose how many points you want to collect, if you want to collect photos, and if the points need to be colorized or not. You may not want to collect photos or have the scans colorized automatically as this slows the scanning and processing time. You can collect panoramas and complete the process of colorizing the scans at a later time once complete with the project or at the end of your day.

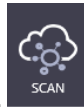

1. Tap the **Scan** icon.

2. Select **Collect**.



3. Tap on the **Scanner Settings** icon in the lower portion of the screen.

4. You can change the scan Density, Sensitivity, Image capture settings and set the Lighting options using each drop-down next to each option. You can also view how each option will affect the scan time, number of points captured, and the point cloud spacing with the display on the right side of the screen.

Scan Settings		Estimates
Density	Low ▲	02:34 minutes 12 million points
<input type="checkbox"/> High Sensitivity		
Image	Fast ▲	Point Spacing 1/4" @ 16 ft 1 9/16" @ 115 ft 3 5/8" @ 262 ft
Lighting	Automatic ▲	

5. Tap the **Scanner Settings** icon again to close the screen and return to the Collect screen.
6. Tap the **Start** button to begin the scan process. You can also quickly press the power button on the scanner to start the scan process as well.
7. A blue message bar will appear showing that a pre-scan calibration has begun. You will have the option to cancel.



8. Next, a message will appear showing a percentage complete. This message also gives you the option to **Pause** or **Cancel** the scan.

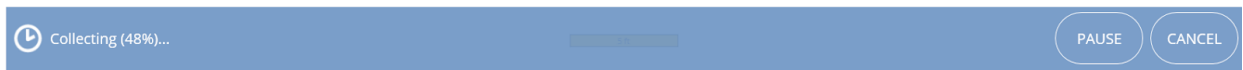

9. If you have not already established the X7 location, you will be given the option to manually place the scan once it is complete and loaded onto the tablet.

9.3.1.1 Fast Capture Mode

Fast capture mode allows the user to capture scans without having the X7

Density

Low Range Fast Capture

This limits the capture range to 30m

instrument self calibrate every time. This saves the user an average of 60 seconds per scan. To initiate this setting:

1. Got to **Scan > Collect**
2. Select the **Scan Settings** button
3. In Scan Settings select Low density and check the box that says "**Low Range Fast Capture**"

Please note that there are several caveats to using this mode.

1. **The range is no longer 80 meters but limited to 30 meters**
2. **You must have the latest firmware version on your X7 for this mode to properly function (reference the release notes for the latest version of FieldLink for firmware version required)**
3. **The scanner must run a calibration routine every 60 minutes so please be aware that the instrument may do this without you telling it to do so**
4. **If the instrument detects a temperature change of greater than 15°C it will run a full calibration routine**
5. **The accuracy of registration may deteriorate the further you get from the leveled and calibrated scan so please adapt your scanning methods to accommodate for this.**
6. **This mode disables touch to turn functionality inside of X7 vision**



9.3.2 Camera Settings

When selecting your camera settings to capture images while scanning, the dropdown menu will give you several options depending on your environment. While Automatic is recommended for most situations, if you are exposed to direct sunlight and notice the instrument is in a direct stream of light, switching to daylight may assist the instrument in correcting the image settings to the situation.

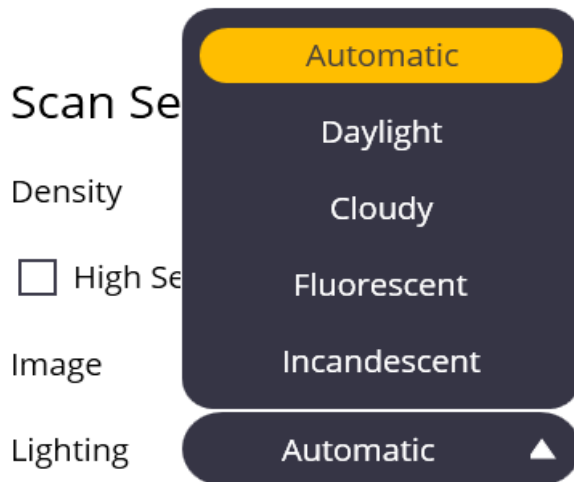

If the environment is too dark, an error message may appear indicating that image collection may take longer than usual due to the instrument being in a dark environment.

High Quality vs Fast: selecting High Quality image capture will cause the collection process to be longer because the instrument will be taking more photos than during the fast capture process.

HDR: Allows the instrument to collect HDR (high dynamic range) images which will assist in bringing out the highlights and contrasts in the photo. This process will increase the amount of time it takes to capture images.

9.4 Viewing Scans in FieldLink

After scanning an area, you will have the ability to view the scan three different ways - plan view, station view and perspective view. Each of these views offers unique features that can help you access information immediately.

9.4.1 Viewing Options Ribbon

The ribbon on the bottom left of the screen holds several different options for how to view your scan data. This includes station color options, point size, station markers and numbers, and cloud view options.



9.4.2 Scan Data Colors



Station Color - shows each scan station as a different color. The colors are automatically assigned during the scanning process.



Intensity - shows the reflectivity of the surfaces or objects in the scan. Blue and darker areas on a scan mean the area is more reflective from the scanner perspective. Red means the area had more absorptive surfaces from the scanner perspective. Highly absorptive or reflective surfaces may cause loss of point data or less dense scans.



Grayscale - shows the scans in grayscale. Grayscale is useful to view data even if there is no ambient light available during the scanning process.



Truecolor - shows the scan as it's true color. The software overlays the colored photos from the instrument and matches it point by point with the data to show the point cloud in its real colors. This option is only available if you have colorized your scans.

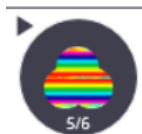

Elevation - shows elevation lines to represent where each part of the scan is along the Z-axis. This can be used to align scans that are not registering along the Z-axis.



Registered Groups - shows each registered group as a different color. You can group scans by different areas, floors, or regions for easier registration, viewing, or exporting.

9.4.2.1 Changing Scan Elevation Settings

When selecting the "Elevation" color option, users can set the distance between color repetition or choose to turn off the repeating color pattern in order to customize their elevation data. To do this:

1. Open the Viewing Options ribbon and select the colors icon until it cycles to Elevation view. The **elevation settings icon** will appear in the ribbon
2. Tap on the **elevation setting icon**
3. A purple crosshair will appear on screen. This is setting your lowest elevation mark for your customizable elevation bar. This is by default at 0. In order to edit the lowest elevation mark, you must tap on the crosshair. A message saying "Please pick the starting point" should appear.
4. Once a lowest point has been established, select an endpoint by tapping on the screen. Note: if you want to lock the Z axis, select the Z axis lock icon in the bottom left corner
5. If you do not want the elevation colors to repeat, you can uncheck the Repeat checkbox.
6. The edit icon in the center of the bottom toolbar will allow you to manually enter elevations

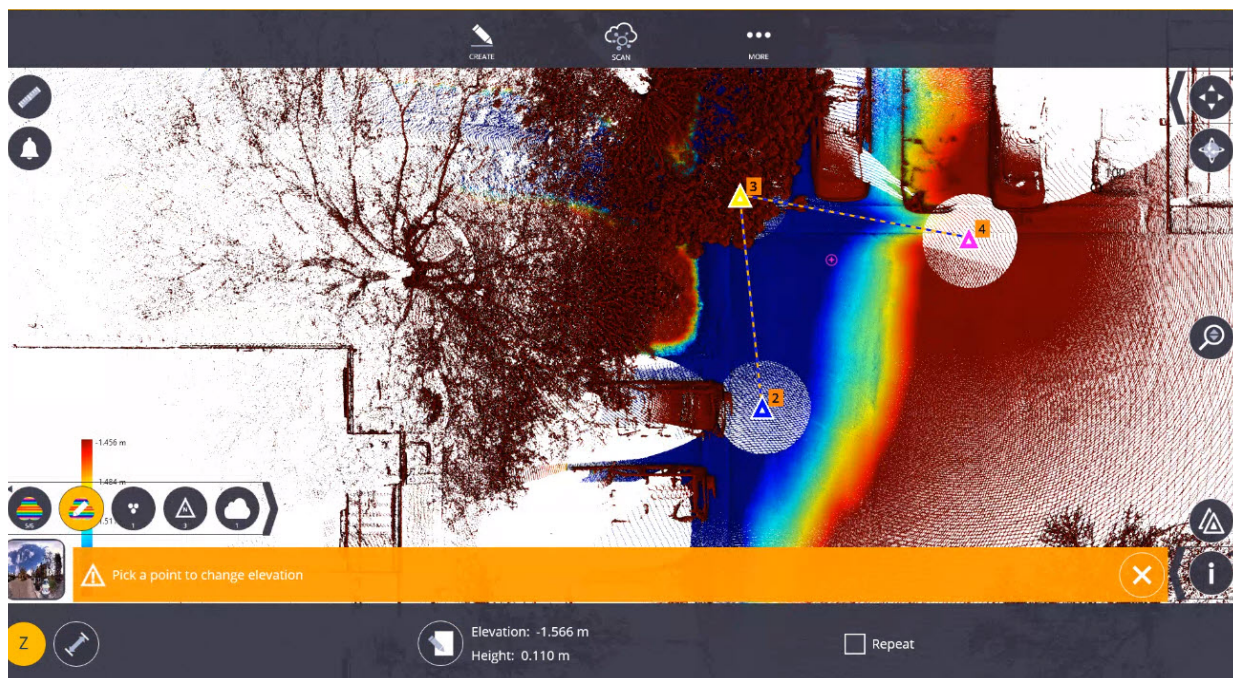

9.4.3 Point Size

You can select from three different point sizes - 1 pixel will give you a small point while 3 pixels will give you a thicker point.

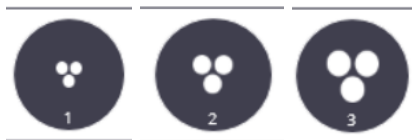

9.4.4 Station Markers

You can turn on and off the station markers and numbers to better view the scan data.



Station Markers OFF



Station Markers ON. The color of the triangle relates to the automatically assigned scan color.



Station Marker and Station Numbers ON

9.4.5 Point Cloud View Options

The default option on a point cloud is to have all the points visible and allow the user to navigate in and around those points. There are three options under this icon.



Full Cloud - the default option that allows you to see the point cloud in its entirety.



Look Inside - allows you to remove the data from the ceiling/roof/walls in order to see a floor plan view of your scan data without having to create a section box or go to the station view.



Outline - only shows the outline of walls, structural steel, pipe, or other features, allowing for easy visualization of the floor plan and edges.

9.4.6 Plan View

Plan view allows you to see a top-down view of the scan.

1. Tap the **More** icon.
2. Select **Map**.
3. To recenter the scans on your screen, press the four-arrow icon in the top right ribbon.



4. This ribbon also contains multiple views including plan view, two elevation views (front and right), isometric view, and the plan view, or switch between parallel and perspective views.
5. You can also use the orbit button to navigate freely through the data in 3D.



9.4.7 Station View

Station view allows you to view the point cloud or images from the X7 perspective. This view includes an almost 365° panoramic view of the area around the instrument. You can also access the perspective and panorama views from the Station View.

1. Select the station view window located at the bottom left of the Map. It will, by default, show Station 1 in Group 1.
2. Once inside of the station view, there will be two dropdown menus - one to select the Group and one to select the station number inside of that group.

You can also cycle through stations using the arrow icons.

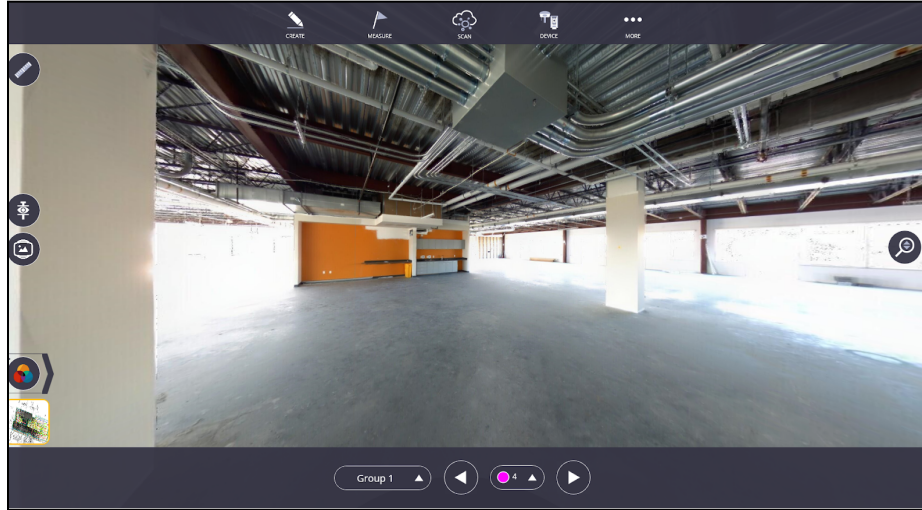

3. You can now use the View Options Ribbon to change the color of the scan. You can cycle between four options - grayscale, true color, unmeasured points, and scan intensity.

9.4.7.1 Using Station View to Control Laser Pointer

In the Trimble X7 firmware version R2.1.4 and later, the built-in laser pointer on the Trimble X7 can be controlled by simply tapping on the screen inside of a station view format. To control the laser pointer by tapping on the screen:

1. Collect a scan with the Trimble X7 by selecting **Scan > Collect**
2. Once the scan is complete, DO NOT MOVE THE SCANNER. If you move the scanner then the camera icon will not appear
3. Tap on **Measure** in the top menu
4. Select either **Lay Out** or **Collect**
5. Your Trimble X7 will then automatically level itself and a message should appear saying "Setup has not been completed". You can set up the instrument on two known points at this time but it is not required to use the station view as a controller for the laser pointer
6. Once this is complete, the camera icon should appear. Tap on the **camera icon**
7. You should now be in station view. A message will appear along the bottom of the screen advising you to "Tap anywhere in the scan to point the laser"

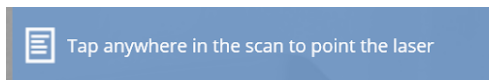

8. Once you tap on the screen, the laser pointer on the Trimble X7 will move and point to that spot.
9. To increase accuracy, zoom in on the screen or walk to where you would like the laser pointer to appear and use the dynamic joystick to nudge the laser into place

9.4.7.2 Tap and Search for Targets in Station View

After scanning an area with targets placed around the site, FieldLink can search and automatically identify targets by using the "Search for Target" feature. To search and automatically identify targets:

1. Open Station View
2. Tap a target in view then select the check box titled **Search Target**. If a target cannot be found, try using a different station view to search for the target
3. Use the edit icon to edit the marker name and description
4. Perform this step for all the targets in view of the scan
5. Once these points are selected, then a regular resection or measurement can be performed.

9.4.8

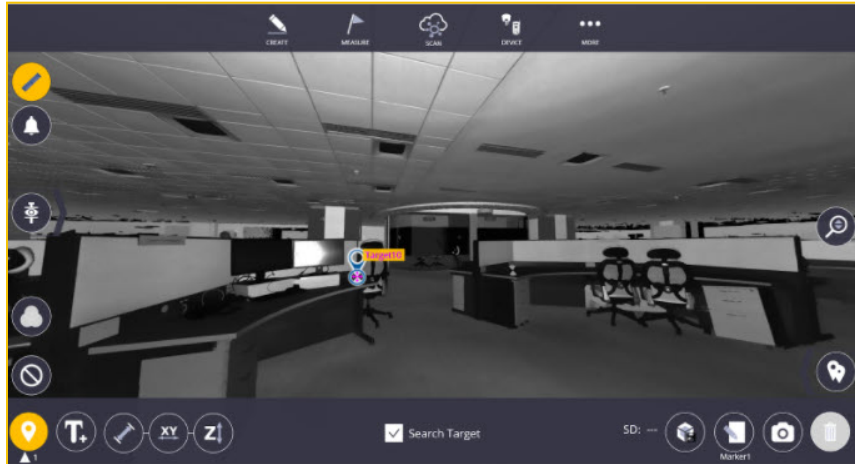

Perspective View

You can find Perspective view and panorama view on the left side of the screen inside of station view. In Perspective view, you are still viewing from the instrument perspective but now you can see the point clouds and any background PDF's, plans or models loaded into the project.

1. Inside of Station View, select the **Perspective** Icon.
2. On the bottom of the screen, you can navigate between stations and groups.
3. The zoom slider on the right side of the screen can assist in zooming in on the



point clouds. You can also use pinch to zoom.

4. Perspective View also has the Viewing Options Ribbon to change the appearance of the point cloud.
5. To exit Perspective View, either select the Perspective View icon again or select the map on the bottom left corner.

9.4.8.1 Viewing Panorama Images

Once you have generate a panoramic image (to learn how to create panoramic images see 9.4.9.2), to view them :

1. Open perspective view



2. Click on the ribbon arrow next to the perspective view icon.

3. Tap on the panorama icon 
4. If you have created a High Quality panorama, tap on the Panorama type icon in the lower

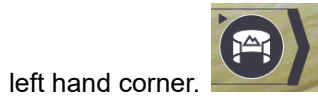

left hand corner.

5. By tapping on this icon, you can cycle through HD panoramas and preview or SD panoramas. Also, by opening this ribbon, you can also toggle the station markers on or off.



To learn the difference between a High Quality and Preview panorama, go to section 9.4.9.2.1

To access these images, please make sure to “Save As” your project after creating your panoramas and go into your systems File Explorer where they will be located under **This PC > Documents > Trimble FieldLink > Jobs > Job Name.dat > Scans > Images > HighResolution.**

9.4.9 Station Manager

Station manager allows you to hide and unhide scans, colorize scans, create panoramic images, check to see what station each scan is registered too, check the size of each point cloud, delete scans, and select and highlight individual or groups of scans.



- Select/Deselect all button



- Panorama and Colorization button



- Layer Assignment button



- Scan Delete button



- Hide/Unhide all button

9.4.9.1 Colorizing a Scan

To colorize a scan:

1. Tap on either the group or individual scan you would like to colorize.

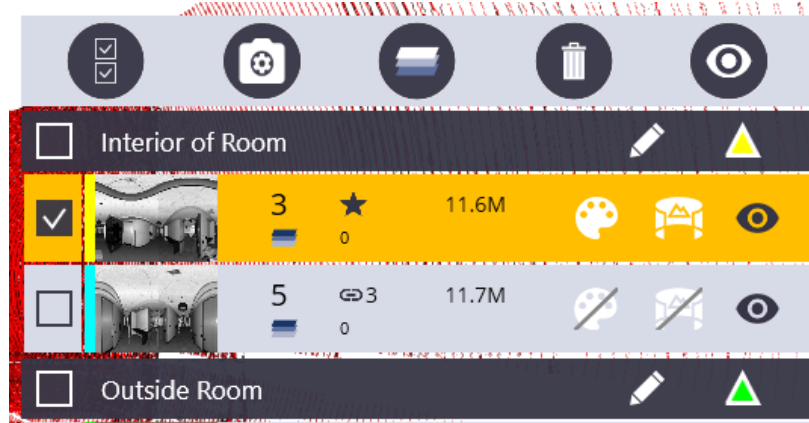

2. Tap on the **Panorama and Colorization** icon.
3. When the settings menu opens you can now either "Colorize Point Cloud", "Generate Preview Panorama" or "Generate High Quality Panorama". In this case, select **Colorize Point Cloud**.

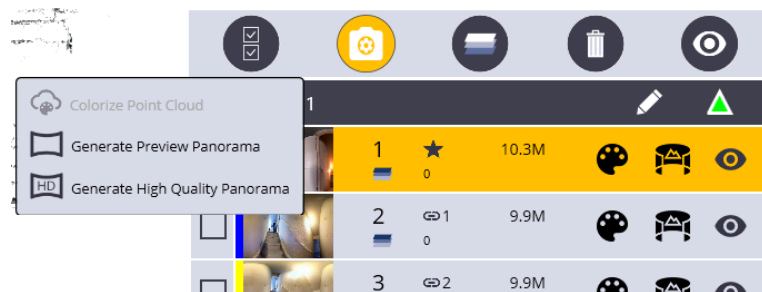

4. Once you tap on that, the art palette icon will begin to spin. This means the program is working on colorizing this point cloud in the background. You can check the status of this process by tapping on the notification bell in the top left corner.

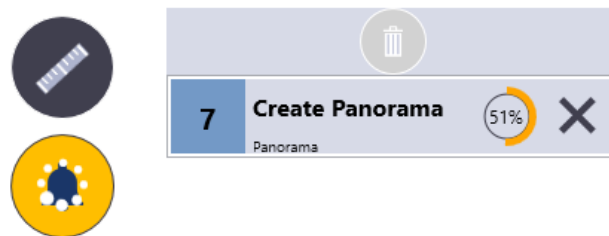

9.4.9.2 Creating Panorama

To create a panorama:

1. Tap on either the group or individual scan you would like to generate a panoramic image for.

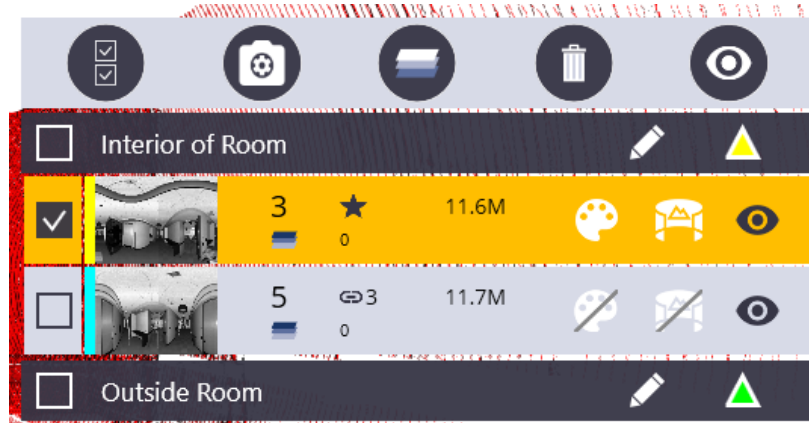

2. Tap on the **Panorama and Colorization** icon.
3. When the settings menu opens you can now either "Colorize Point Cloud", "Generate Preview Panorama" or "Generate High Quality Panorama". In this case, select **Generate Preview Panorama** (see 9.4.9.2.1 to read about the difference between High Quality Panorama and a Preview Panorama).

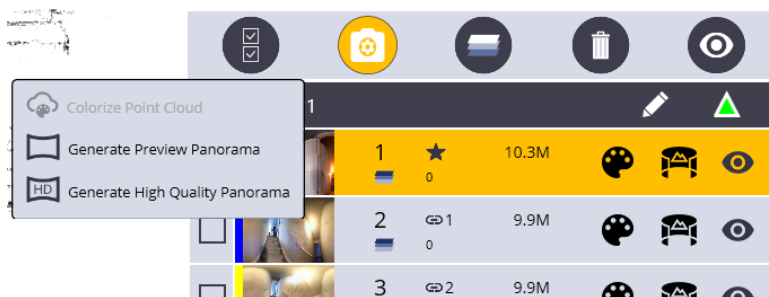

4. Once you tap on that, the art palette icon will begin to spin. This means the program is working on creating a panoramic image in the background. You can check the status of this process by tapping on the notification bell in the top left corner.

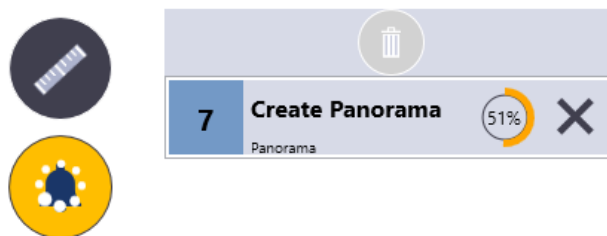

Differences between High Quality Panorama and Preview Panorama

The differences between a "High Quality" generated panorama and a "Preview" panorama is that the High Quality image that is generated smoothes out the stitched edges between each of the images in the panorama and creates a seamless image. However, in doing so, it diminishes the visibility of items in each of the photos. So, for example, if you had text in one of the pieces of the panorama, it would become a bit blurry and hard to read. The "Preview" panorama looks more cut together and blocky because it keeps the full resolution of each individual image in the final

stitched panorama. This allows you to zoom in on a part of the image and be able to interpret items that are shown in the image such as text. See examples below:

PREVIEW:





HIGH QUALITY:



9.4.9.3 Assigning Scans to Layers

When you have a model inside of your FieldLink Job, along with several scans, annotations, markers, layout points, etc. it can become difficult to navigate around the project. Assigning a scan to a layer inside of your model once everything has been aligned can greatly assist you in the process of hiding and isolating areas where you want to focus your attention. To assign a scan to a layer:

1. Open Station Manager 
2. Select the station/scan you would like to assign to a layer
3. Tap on the Layer Assignment icon 
4. The Layer Assignment menu will appear and you will have the option to either create a new layer or open up your layers panel to assign it to an existing

layer.

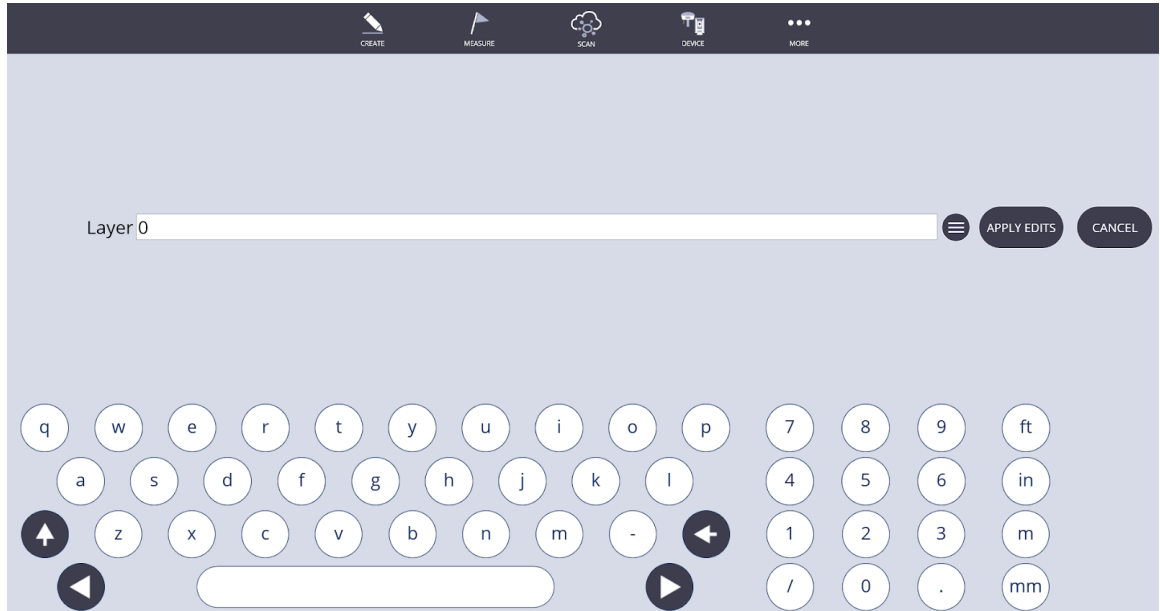

5. To assign to an existing layer click on the menu icon to the right of the text



box.

6. Select which layer you want to assign the scan to and then tap on the Apply Edits button to close the menu.

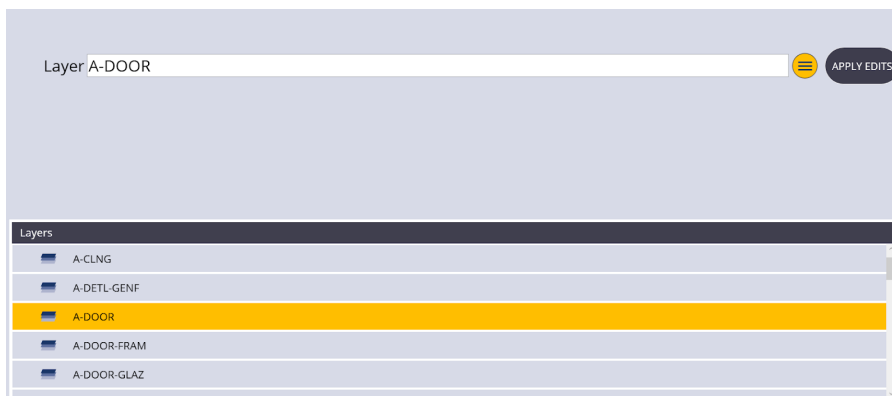

7. Now when you open the Station Manager you will see next to the station number that the scan has been assigned to a layer. When you manipulate this layer through the settings menu, this scan will be affected as well.

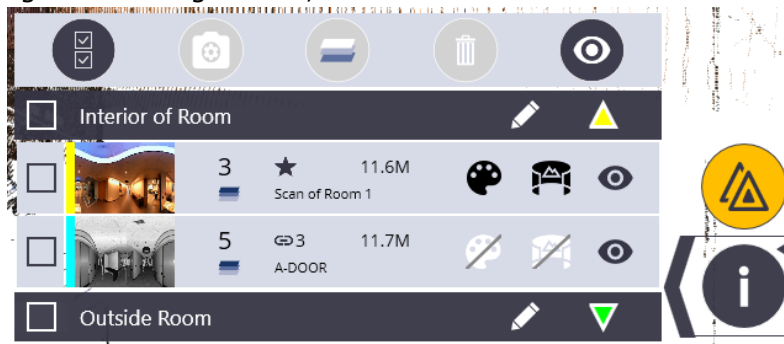

9.4.10 Extract Detail/Density from Region Within Scans

When viewing point clouds in FieldLink, only a percentage of the points in the point cloud are displayed. In order to view all of the points in a desired area of the scan, you will need to extract the extra points by:

1. Tapping on the information ribbon and selecting the **Section View** icon. If your model has many independent sections, you can shrink your Section View with the arrows to encompass the only section of interest. If your model is a 3D model, you can select the 3D icon in the top right to be able to shrink your model in the 3 axis if desired.
2. In the **Section View**, select the **+** sign to create a new section view. You can select the pencil icon to rename your new Section View and give it dimensions of desired.
3. Once your new Section View is created, select the cloud icon next to the section view you would like to increase the point density on.
4. Once FieldLink has processed the extra points, you can toggle this dense section on and off by tapping on the cloud icon again.

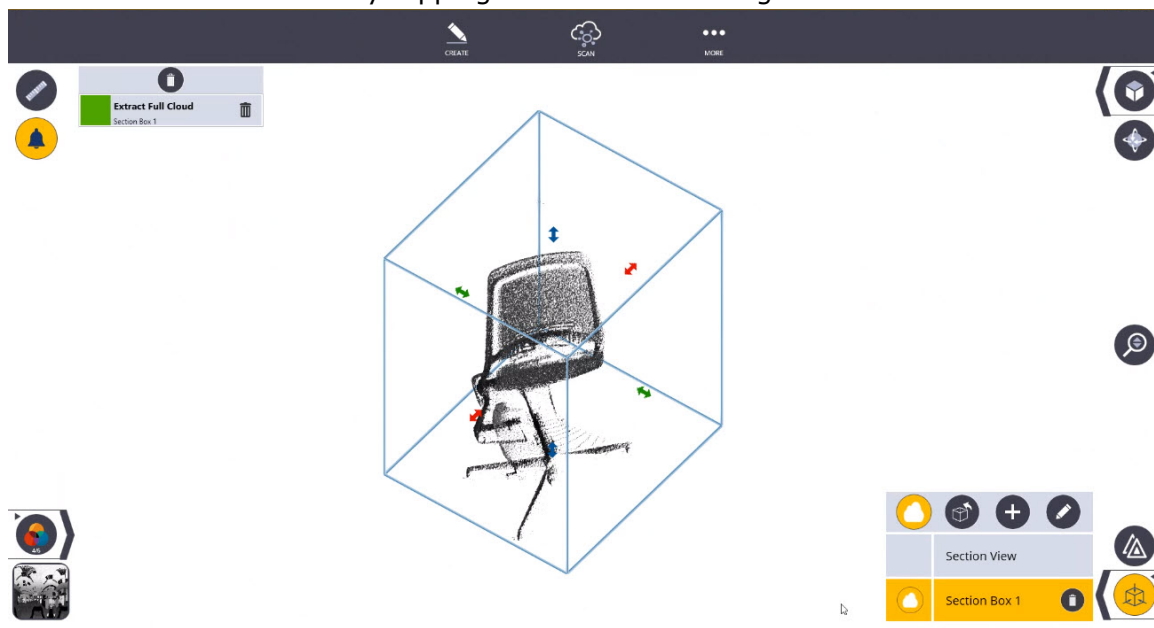

9.4.11 Create TFL Points from Scanned Data

In most cases, a field point is required in a project in order to layout a point using an instrument. Creating a field point can also help when measuring between a model and point cloud. To create a point from scan data:

1. Select the **info** icon in the bottom right corner
2. Select a point on the point cloud. A circle should appear around where you selected
3. Select the **Create Point** button under the info button

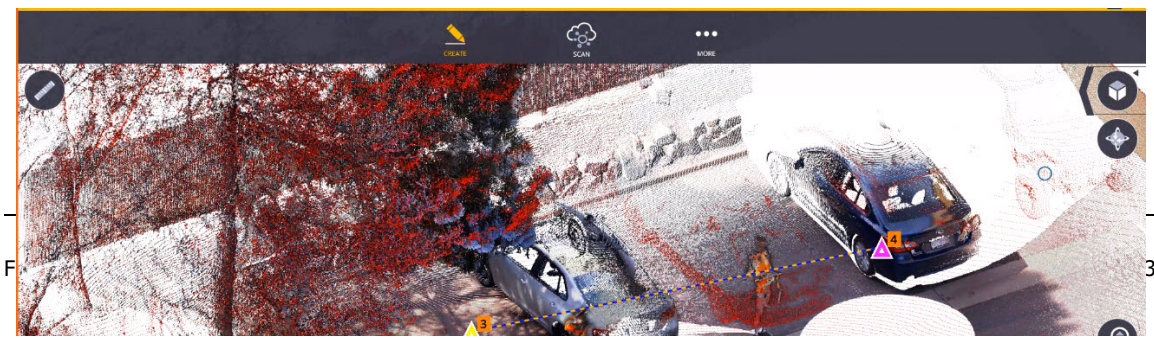

9.5 Measuring/Calculations

Both in viewing the point cloud on the Map and inside of Station View, you can measure between points in the point cloud. You can also measure between the model and the point cloud by using **Create** > **From Model** and creating points on the model that the measure tool can reference from the point cloud.

1. Once in Station View, select the measure/calculation tool. 
2. You will have the option to lock the measuring tool either to the XY-axis, Z-axis or to leave it unrestricted. The following bar will appear:

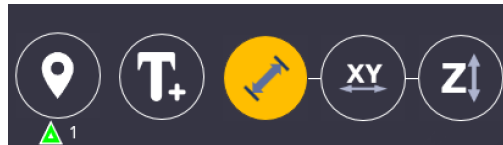

3. Once you select the type of measurement you want, click on two separate points on the screen.

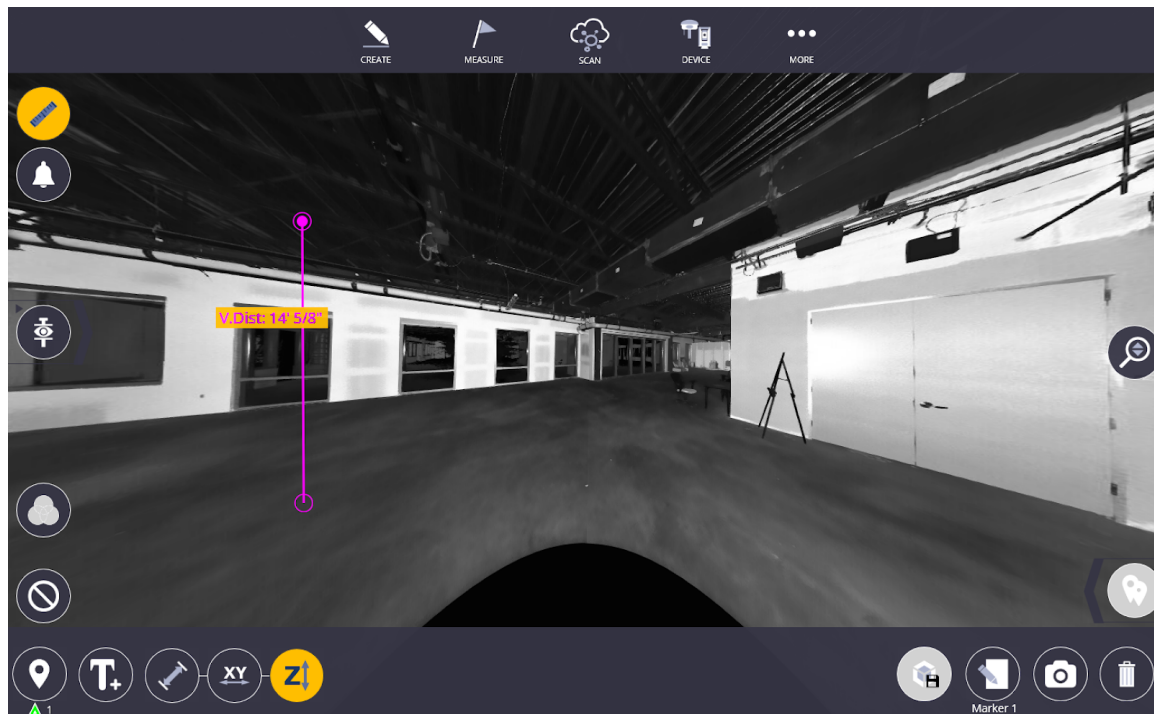

This is an example if you are using the Z-axis lock. Once you select a point on the ground or ceiling, the software will automatically follow the z-axis on your next click. The measuring tool will measure parallel distances between walls on an XY-axis lock.

9.5.1 Screen Capture/Screenshot

In a situation where you would like to save the calculations you have made on the screen, the screen capture feature allows you to save a screenshot of your current view in the station view directly on your device. To take a screenshot:

1. Go to station view by selecting More > Map and tapping the bottom left-hand corner. This will also work in plan view after selecting More > Map.
2. Select the calculation tool in the upper left corner.

3. Once you have completed your measurements, a camera icon will appear in the bottom right corner of the screen. Make sure you have everything you want to capture in your current viewing window because that is what will be saved once you tap on this icon:

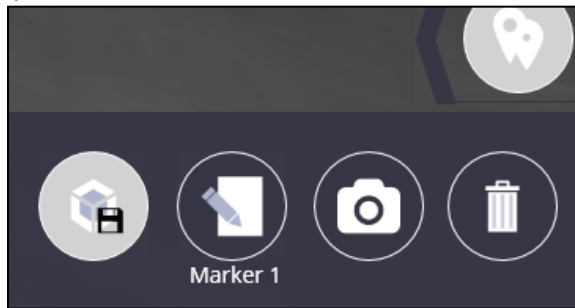

4. A menu will appear saying:

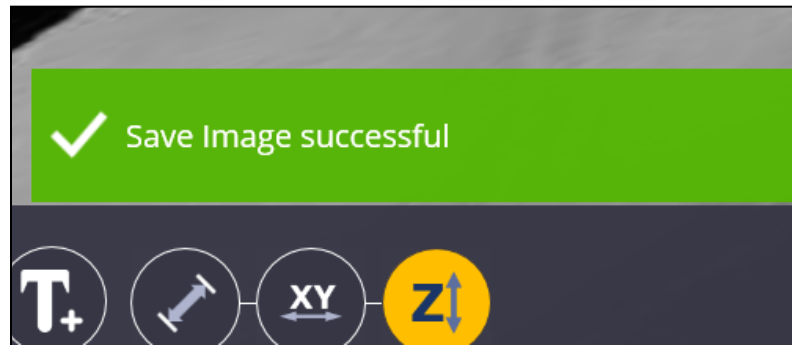

The default folder that your image will be saved into is: This PC > Documents > Trimble FieldLink > Images and in the folder named after the current project name you have open.:

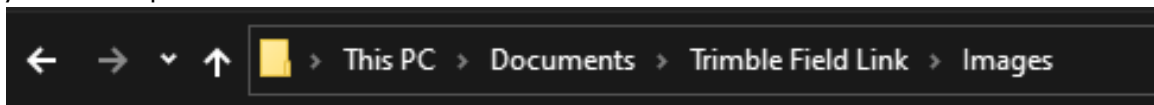

If you want to change this file location, select the Edit icon next to the Camera icon. Once in this menu, select the Folder Icon to the right on the screen and use the file explorer to select which folder you would like to save your screenshots to.

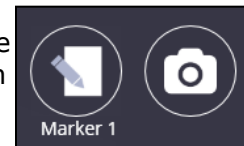

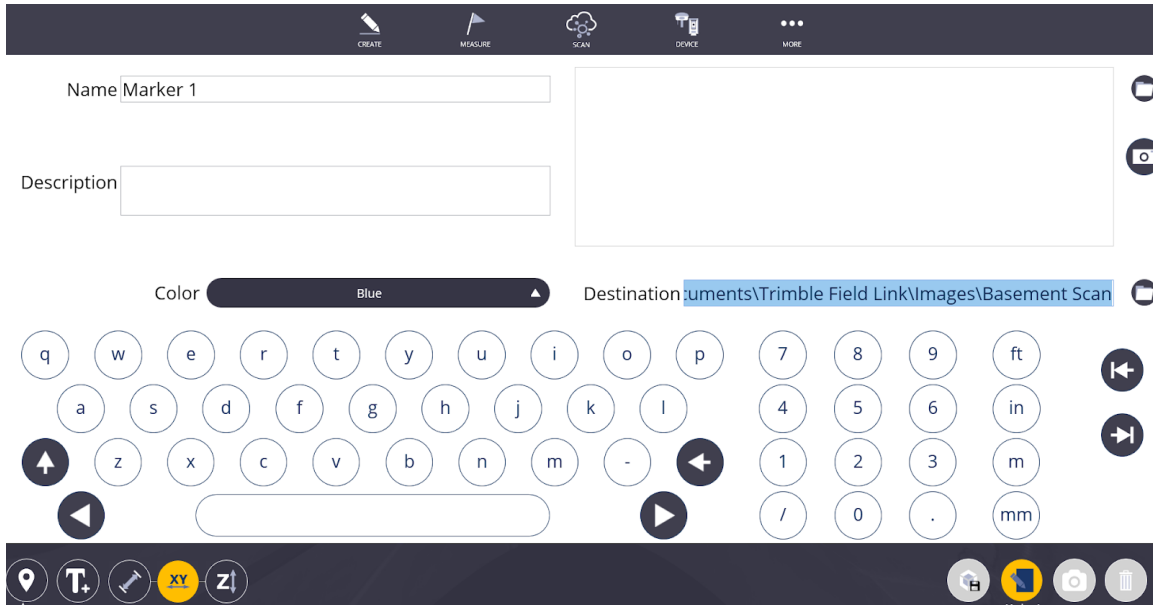

9.6 Annotations and Markers

When scanning complicated projects, it may be difficult to identify objects of importance or of interest. By adding an annotation or marker, this can call attention to things that need to be fixed, changed, replaced, or generally highlighted.

9.6.1 Adding an Annotation

1. Select **More** > **Map** and **Station View** in the bottom left corner.
2. Tap on the **Calculation** icon.
3. The marker and annotation icons will appear next to the XY and Z lock measurement icons on the bottom left corner of the screen.

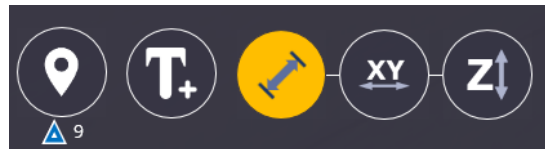

4. Select the **Annotation** icon:
5. Once the annotation menu appears, you will have the option to enter in your desired text with the built-in keyboard.

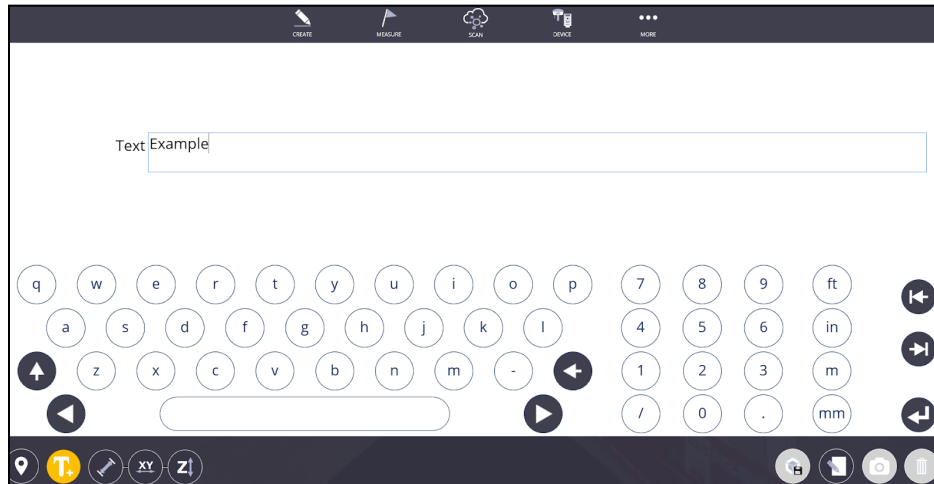

6. Once you have entered your text, tap on the **Annotation** icon that is highlighted yellow to close this menu.
7. Now you can tap on where you would like the annotation to appear.

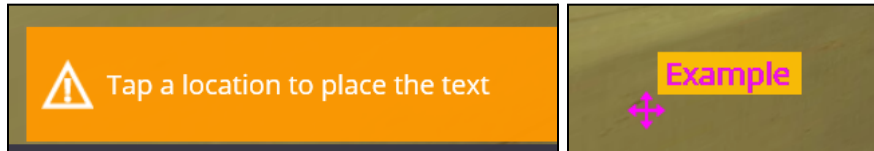

8. To move the annotation to another location, click and drag on the pink arrows and drag to where you would like to relocate the text.



9. To change the text, tap on the **edit text** icon
10. To delete an annotation, tap on the annotation you would like to delete and select the **trash can/delete** button in the bottom right corner.

9.6.2 Adding a Marker

1. Open **Station View**



2. Tap on the **Marker** icon. The marker icon will show a small triangle with a number next to it. This represents which station view you are in.
3. Tap where you would like to place the marker. You can move the marker to another position using the pink arrows next to the marker.

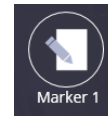

4. To edit the marker, tap on the **edit marker** icon
5. Once in the edit menu, you will have the option to change the name of the marker, the marker description and the marker color.
6. To attach a photo to the marker, tap on the **camera button** to open your device's camera to capture a photo or tap on the **file icon** to upload an existing photo from your device.
7. Once your edits are complete, tap the yellow edit marker icon to exit the edit menu.



- To delete a marker, tap on the marker you would like to delete and tap the trash can/delete button in the bottom right corner.

Another feature of the markers is the ability to save a view based on the markers you add. To do this:

- After creating a marker, the **Save View** icon will appear. Select this icon



- A menu will pop up saying that the "Current view has been saved".
- To see this view again, exit station view (or select More > Map) and tap on the Info icon in the bottom right corner.



- When the info button is yellow, tap on the marker where you just saved your view.
- A menu will appear next to the information ribbon. Select the arrow next "Snapshot Image". This will show you an image of the view you saved so that you may reference it later. It will also show the marker name, station number, description, and XYZ coordinates.

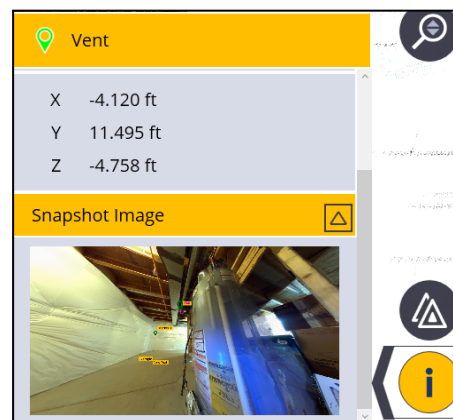
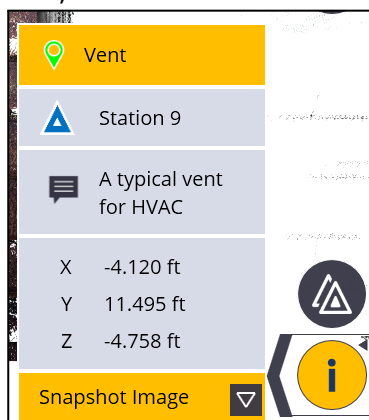

- To exit this view, tap on the **Info** icon.

9.7 Floor Analysis

The floor analysis feature allows you to create a floor flatness and floor levelness report based on your scan data. It also allows you to create contour lines and a grid of points that can be used to aim the instrument at the high and low points.

9.7.1 Floor Flatness and Floor Levelness

To create a floor flatness and floor levelness report:

1. Select the **Scan** icon in the menu bar and select **Floor Analysis** towards the bottom of the menu.

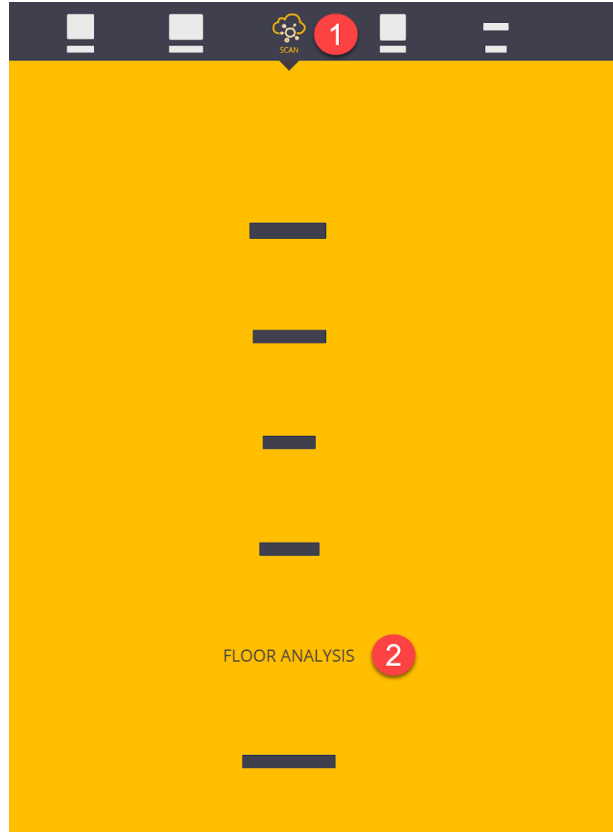

2. Make sure the **Floor Flatness/Floor Levelness** icon is selected in the bottom left-hand corner.
3. Select the **Floor Selection** tool located above the information ribbon.
4. Once selected, a menu will open. Tap the **+** icon to add a new floor
5. Use the red, green and blue arrows to move the limit box to show only the floor of the area you would like to analyze, being sure to adjust the Z-axis as well.

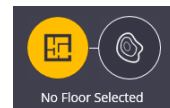

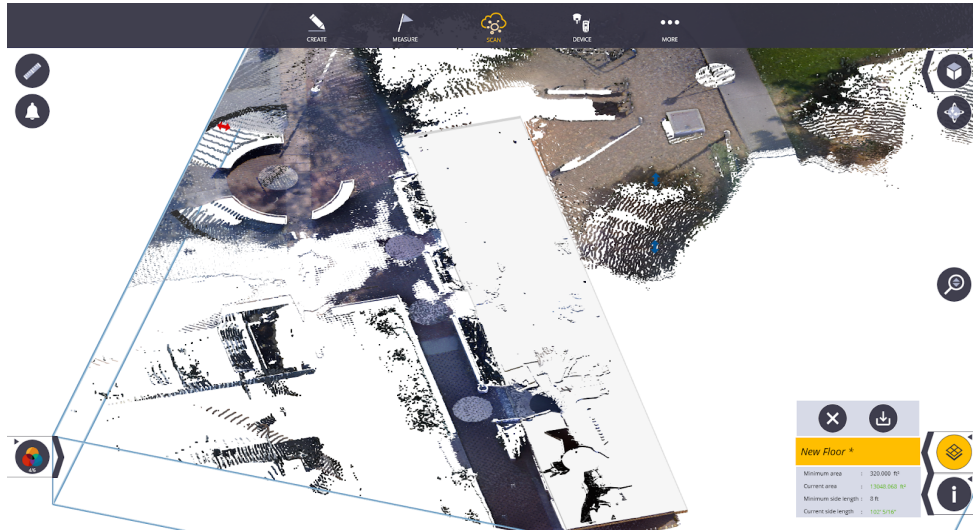

6. Once you have selected the region you want to analyze, press the **confirm** button
7. After tapping on **confirm** your floor will now be extracted with the selected points. Once the extraction is successful, select the **save** icon to save your extracted floor.
8. You can select the **edit** icon at any point to change the name or assigned layer of this extracted floor.



9. To readjust the selected floor from the current extracted points, select the **crop** icon next to the **edit** icon. This will delete your current saved floor.
10. Once you are satisfied with your extracted floor, close the floor selection tool by tapping on the **floor selection** icon.
11. Next, you will be prompted to add sample lines on your floor. Based on your minimum number of reading requirements that is generated based on the size and density of your point cloud, you may have to create several lines to meet this requirement. Select the **+** icon to create a line. The minimum line length is 11ft.



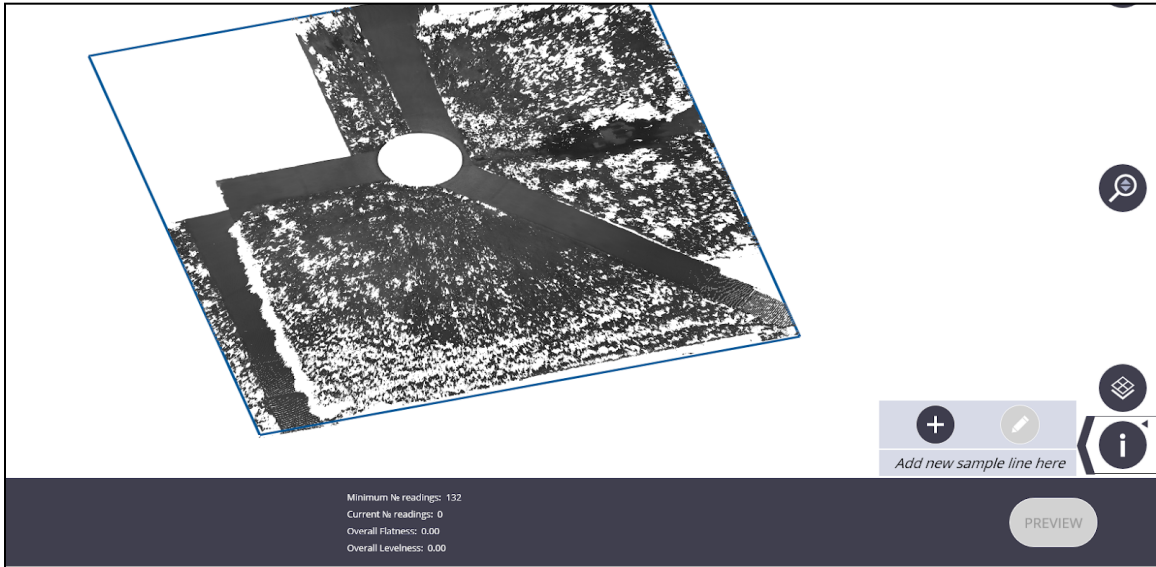

12. To create a line, tap on one point on the floor and then drag your finger across the floor a short distance away from the first point to determine the length of line you would like to use. You can adjust this line by tapping and dragging the endpoints or by tapping and dragging the complete line.
13. When you are satisfied with the length and location of your line, select **accept**.
14. Repeat this process until you have met the minimum number of reading requirements. You can alternate the direction of the lines as well as overlap them.

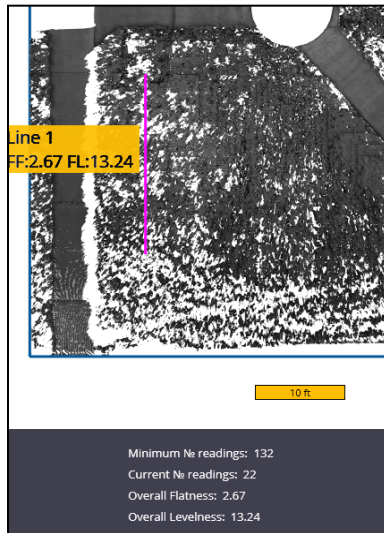

15. When you have met the minimum number of readings, a **preview** button will appear.
16. In the preview menu, you can edit the minimum local value and specified overall value for both the floor flatness and floor levelness. Once complete, select the **preview** button to view the report. To go back to the map, select the **map** button.
17. The Floor Flatness Report will be automatically generated and presented to you once it finishes processing.
18. Once you have viewed the report you will have the option to save the file.

Floor Flatness Report

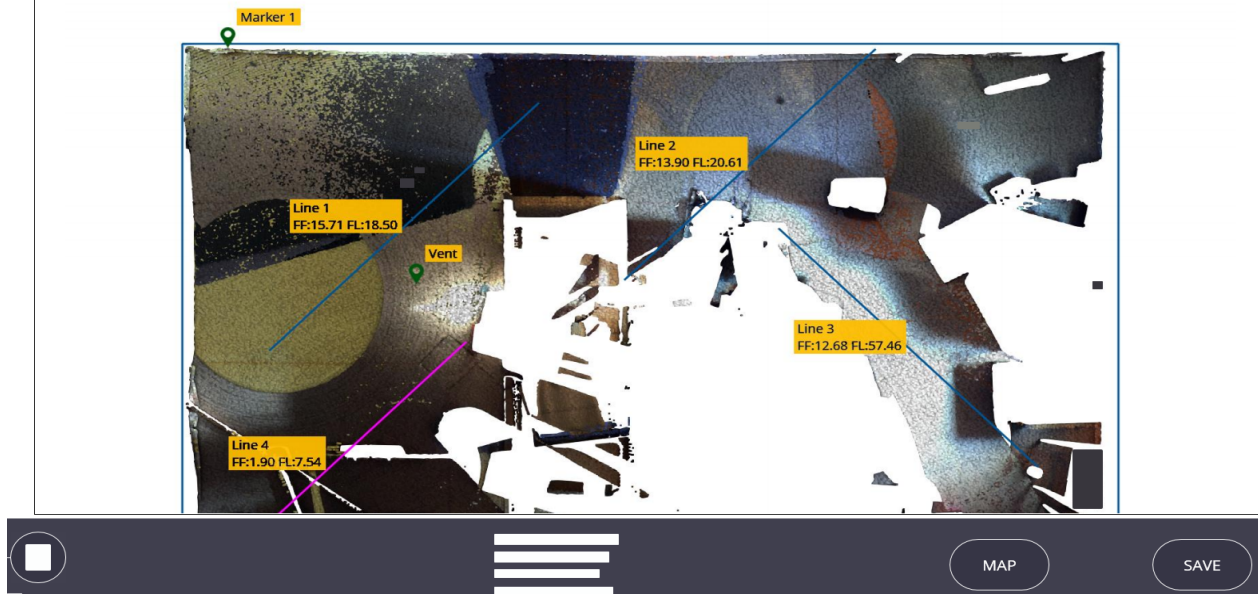

9.7.2 Contour and Point Creation

To create contour lines and points that allow your instrument to aim to:

1. Begin by selecting the **Scan** icon in the menu bar and select the **Floor Analysis** option near the bottom of the menu.
2. Make sure the **Floor Contours** icon is selected in the bottom left-hand corner.
3. Select the **Floor Selection** tool located above the information ribbon.
4. Once selected, a menu will open. Tap the **+** icon to add a new floor. If you have already extracted a floor, select which one you would like to analyze and skip to step 9
5. Use the red, green and blue arrows to move the limit box to show only the floor of the area you would like to analyze
6. Once you have selected the region you want to analyze, press the **confirm** button
7. After tapping on **confirm** your floor will now be extracted with the selected points. Once the extraction is successful, select the **save** icon to save your extracted floor. You can select the **edit** icon at any point to change the name or assigned layer of this extracted floor.

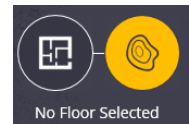

- To readjust the selected floor from the current extracted points, select the **crop** icon next to the edit icon. This will delete your current saved floor.

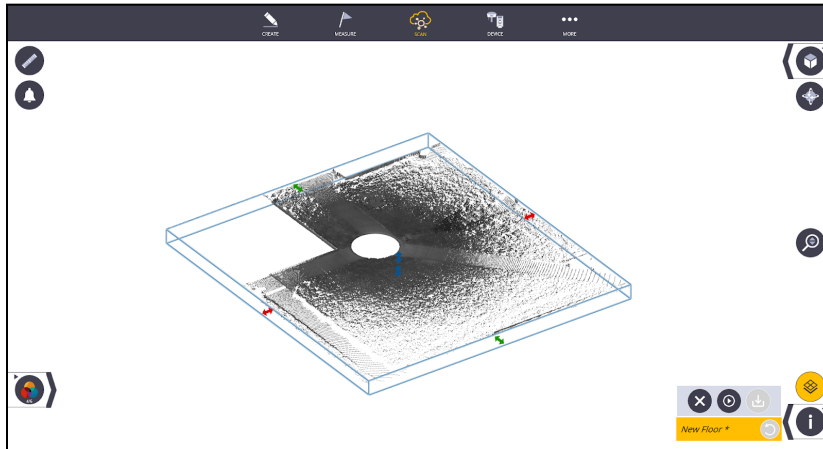

- Once you are satisfied with your extracted floor, close out of the floor selection tool by tapping on the **floor selection** icon again.



- The contour lines along with the high, in tolerance, and low points will be automatically generated based on the tolerance specifications you set in the edit menu. To change the resolution (distance between points), elevation and tolerance, select the **edit** icon in the bottom center of the screen.

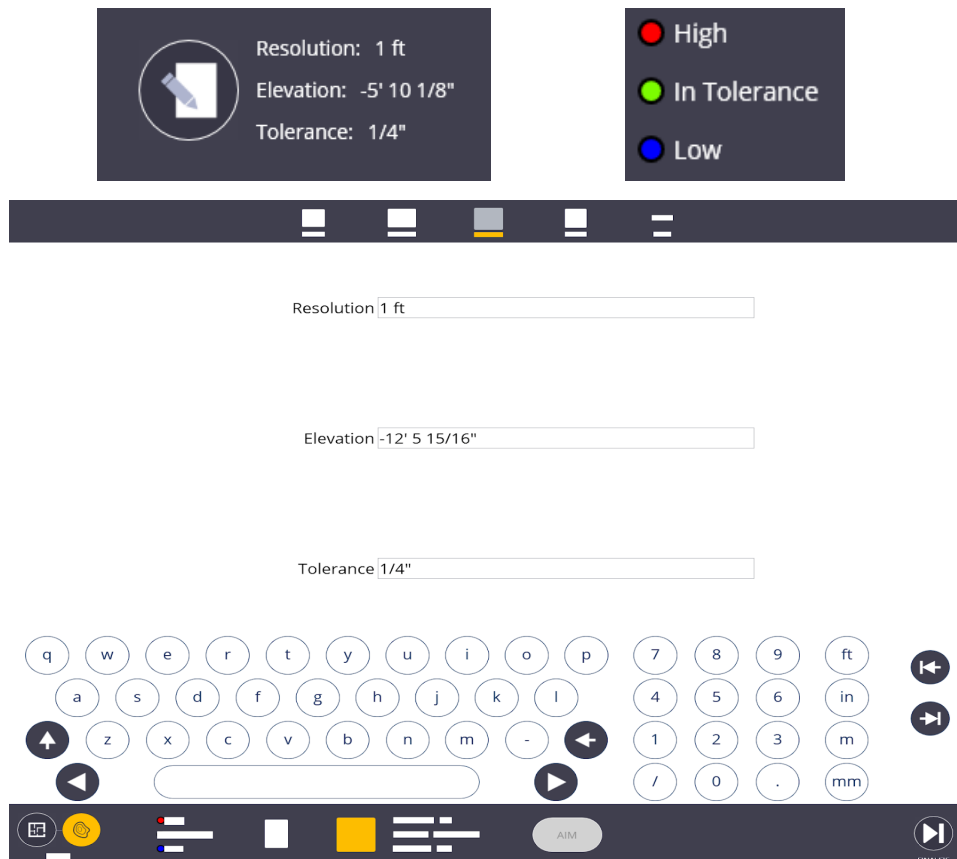

11. Once your tolerance settings are adjusted, select the **edit** icon again to reprocess your grid
12. To change the floor elevation outside of the edit menu, use the **Touch Scan Point** icon and select the individual scan point you would like to change the elevation to.



13. Once you are satisfied with your contours, select the **Finalize** button on the right hand side of the screen
14. The individual points will now be generated and shown on screen. Tap on the **edit** icon on the bottom of the screen to edit the Name, Description and Layer that your points will be saved under. Once complete, select the **edit** icon again to close this screen.



Tip

If you plan to export your generated point as a CSV file, provide a unique description or layer to easily separate these points from other points created in the project. The points extracted from the floor analysis will automatically be added to a default layer named "Floor X"

15. To view the Floor Report, tap on the **report** button on the bottom of the screen.

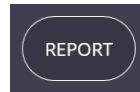

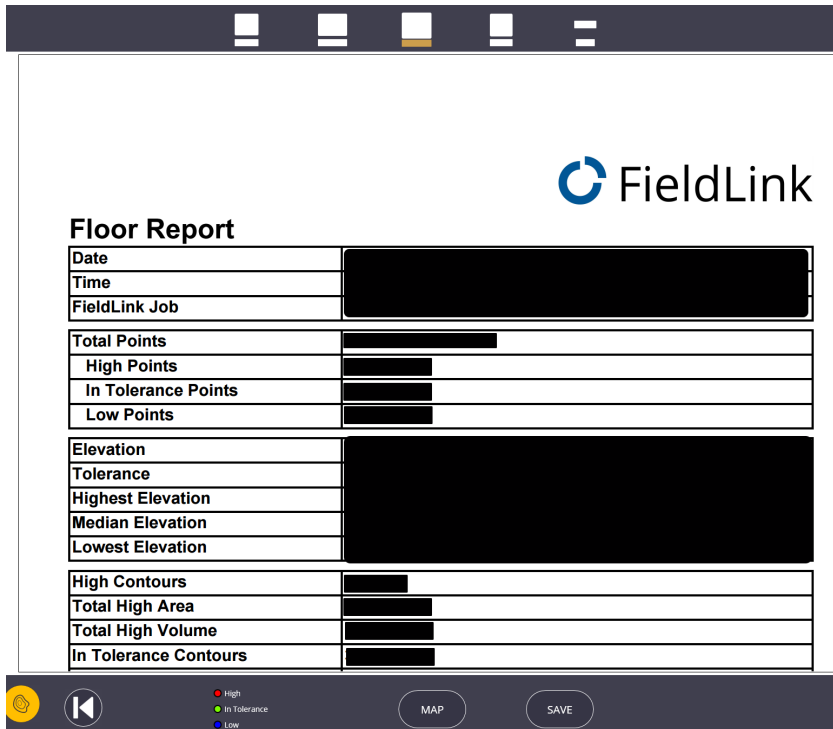

16. Once in the report preview screen, you can either return to the map view or save your report to your desired location.
17. To view your generated points report as a CSV file, navigate to **More > Projects > Export** and filter out the floor points you would like to export. Select CSV as your file type and the press **Export**

	A	B	C	D	E	F	G	H	I
1	NAME	X(ft)	Y(ft)	Z(ft)	DESC	LAYER	ATTRIBUT	ATTRIBUTE1	VALUE
2	Floor_1_0	-29.19	26.811	-5.845	Not stake	0	SurfacePo	Not calculated	
3	Floor_1_1	-28.19	26.811	-5.845	Not stake	0	SurfacePo	Not calculated	
4	Floor_1_2	-27.19	26.811	-5.845	Not stake	0	SurfacePo	Not calculated	
5	Floor_1_3	-26.19	26.811	-5.845	Not stake	0	SurfacePo	Not calculated	
6	Floor_1_4	-25.19	26.811	-5.845	Not stake	0	SurfacePo	Not calculated	
7	Floor_1_5	-24.19	26.811	-5.845	Not stake	0	SurfacePo	Not calculated	
8	Floor_1_6	-23.19	26.811	-5.845	Not stake	0	SurfacePo	Not calculated	
9	Floor_1_7	-22.19	26.811	-5.845	Not stake	0	SurfacePo	Not calculated	
10	Floor_1_8	-21.19	26.811	-5.845	Not stake	0	SurfacePo	Not calculated	
11	Floor_1_9	-20.19	26.811	-5.845	Not stake	0	SurfacePo	Not calculated	
12	Floor_1_10	-19.19	26.811	-5.845	Not stake	0	SurfacePo	Not calculated	
13	Floor_1_11	-18.19	26.811	-5.845	Not stake	0	SurfacePo	Not calculated	
14	Floor_1_12	-17.19	26.811	-5.845	Not stake	0	SurfacePo	Not calculated	
15	Floor_1_13	-16.19	26.811	-5.845	Not stake	0	SurfacePo	Not calculated	
16	Floor_1_14	-15.19	26.811	-5.845	Not stake	0	SurfacePo	Not calculated	
17	Floor_1_15	-14.19	26.811	-5.845	Not stake	0	SurfacePo	Not calculated	
18	Floor_1_16	-13.19	26.811	-5.845	Not stake	0	SurfacePo	Not calculated	
19	Floor_1_17	-12.19	26.811	-5.845	Not stake	0	SurfacePo	Not calculated	
20	Floor_1_18	-11.19	26.811	-5.845	Not stake	0	SurfacePo	Not calculated	
21	Floor_1_19	-10.19	26.811	-5.845	Not stake	0	SurfacePo	Not calculated	

18. The default save location for the reports will be **User > Documents > FieldLink > Reports > Floor Reports** and the default location for CSV exports will be **User > Documents > FieldLink > Exports**

9.7.3 Contour and Point Layout

Once you have collected a scan of the area around you, generated the contour lines and have set-up the instrument on two points, you can now use the instrument to aim at the high and low points on the contour lines. To do this:

1. Ensure the instrument is set up by going to **Device > Set Up**
2. Go to the Floor Inspection contour creating menu by tapping on **Scan**  **> Floor Analysis > Contour Creation**
3. Once the contour lines have been created and the instrument is leveled and set up, you can select a contour line you would like to layout and the individual points that make up that line will appear.
4. Tap on the point you would like to aim the laser pointer at.
5. The AIM button should appear solid. Tap on the **AIM** button

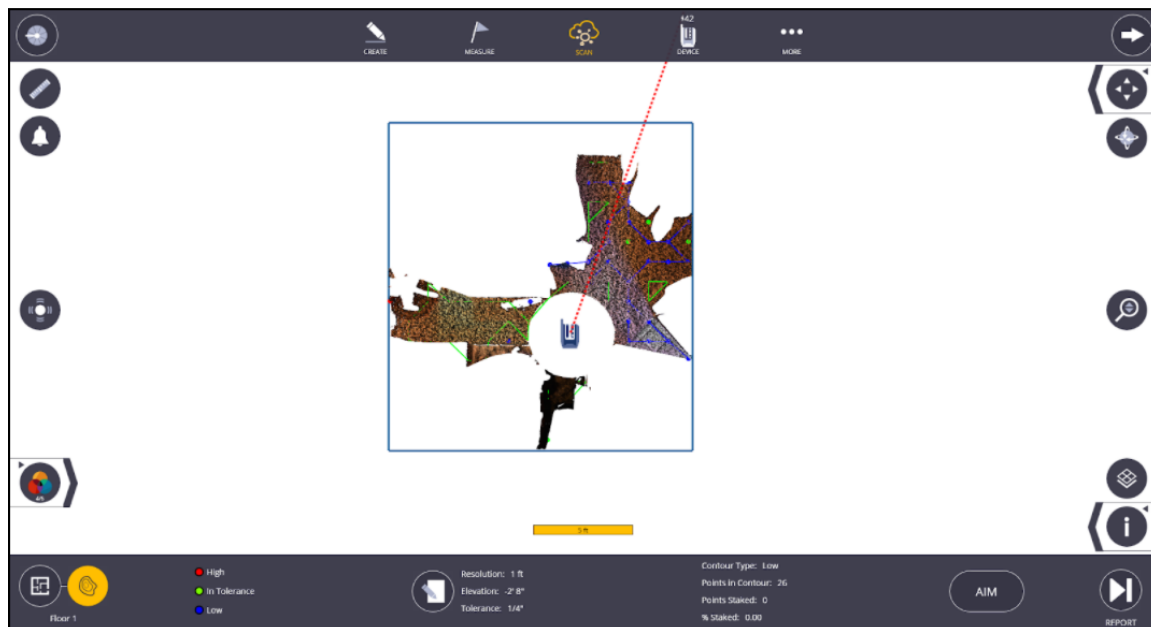

9.8 Inspection

When a 3D model is aligned with your point cloud data, FieldLink allows you to compare your model to compare the two to check for any discrepancies. In order to use this feature, a 3D model must be imported into your FieldLink project and your points must be aligned with the model.



Note

The most accurate way of aligning your scan data with your 3D model is by creating points on the model and performing a resection of your X7 based on those created points. See section **9.2.3** for more.

To use the inspection feature with your 3D model and scan data:

1. Ensure your 3D model and point cloud are aligned
2. Tap the **Scan** icon
3. Tap on **Inspection** 

4. Tap on the **Edit Inspection** icon on the bottom of the screen
5. The Inspection menu will appear allowing you to set the maximum tolerance and tolerance interval, save destination for images and the inspection name



Maximum Tolerance Name

Tolerance Interval Destination 

6. Once these parameters have been set, tap on the **Edit Inspection** icon again to exit
7. Tap on the **Inspection icon** on the lower right side of the screen to begin the model inspection
8. Once the inspection process is complete, an array of colors will appear on your 3D model showing where your data is within tolerance based on the interval you set in the **Inspection Editor**.



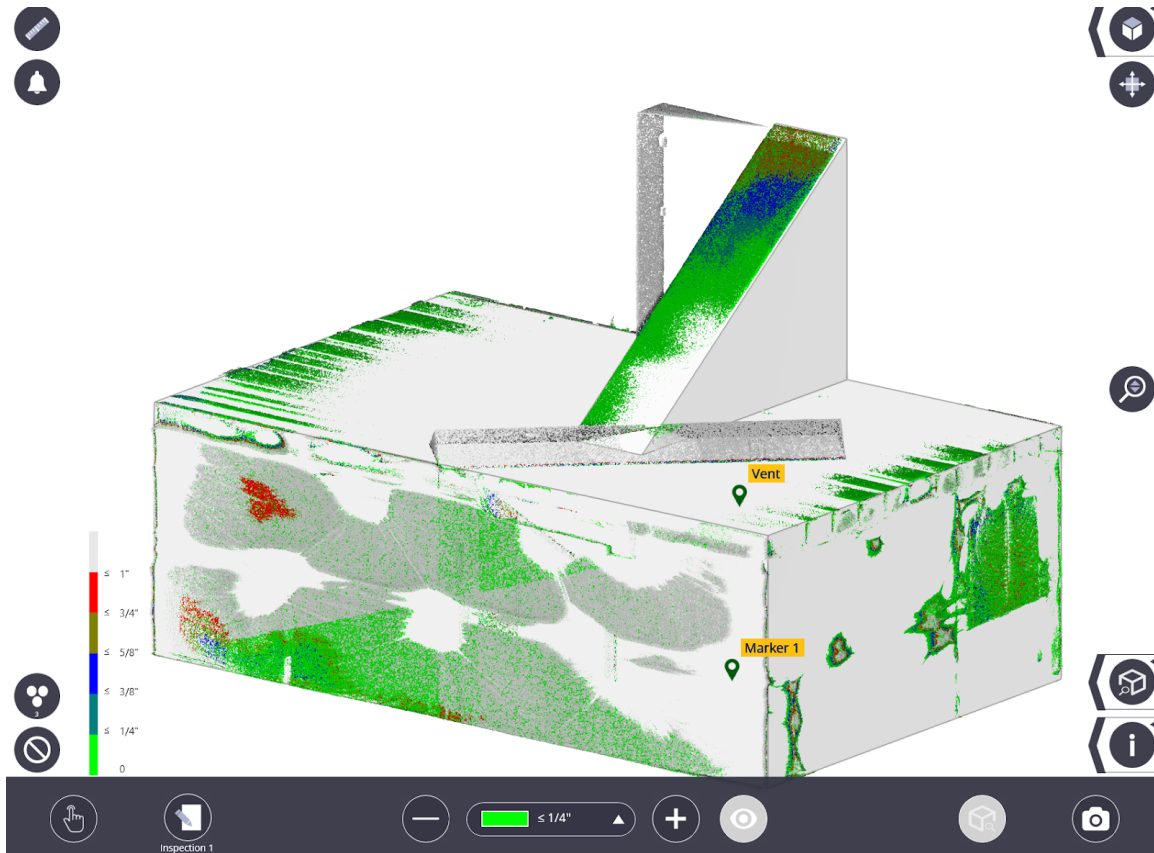

9. You can produce several model inspections with different tolerances within the same project. Simply tap **More > Map** to return to Map view and then go back into the **Scan > Inspection** menu and conduct a new inspection.
10. To toggle between the different inspections, simply tap on the **Inspection ribbon** and select which inspection you would like to see



11. Also you can change the tolerance by the increment you set by using the **+ and - buttons** on either side of the tolerance menu in the middle of the screen This will affect only the color range that is selected and will only change by the increment you set in the inspection editor

- You can also turn off intervals and colors by selecting a color/range in the menu and then tapping on the **eye icon**.

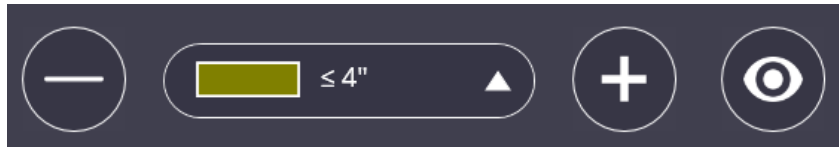

- Using the camera icon in the bottom right corner will allow you to save your screenshots to the default images folder under Documents > FieldLink > Images.

9.9 X7 Scan Registration

If the scanner has at least 2 scans loaded in the active project, you can manually move and register the scans directly in FieldLink if they do not automatically register. There are two options to register your scans manually. You can rotate the scan to a different orientation to better match the orientation of the reference scan or move it to an area where more overlap occurs with the reference scan. An alternative is to use Splitview to select two visible surface planes that are shared between the two stations.

- Tap the **Scan** icon.
- Select **Register**.
- In the dropdown menu on the bottom bar of the screen, select which station you want to move under the **Moving** dropdown. A blue circle with red and green arrows should appear around the station icon that you are now moving.

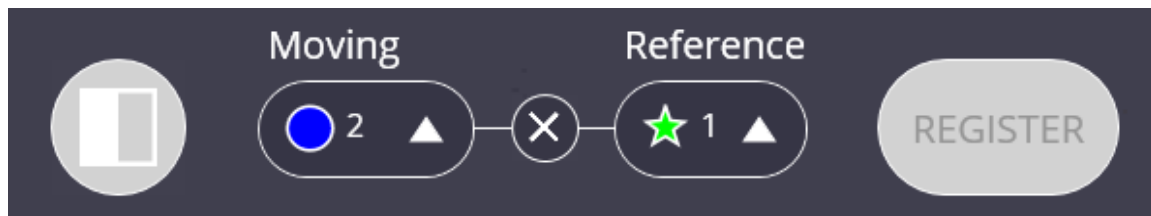
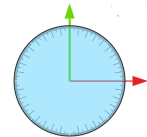

- Select which station you would like this station to register to by selecting it under the **Reference** dropdown.
- Using the blue circle and red and green arrows, move and rotate your scan data to match the orientation of the scan you are referencing in both plan and elevation views.
- When the scan is in the same orientation as the reference scan, tap the **Register** button to register the scans together.
- The 2 scans will now be linked together. To unlink these scans and move them separately, select the **X** between the two station numbers in the bottom menu.
- If your registration refinement fails, you will be prompted with the red pop-up below. If this continues, try the Splitview option.



Registration Failed - Verify scan placement and retry (or) use splitview to register



- To use Splitview, tap the Splitview icon.
- Once Splitview opens, select which station you are moving and which station you are referencing in the dropdown menus on the bottom of the screen (moving station view is on the left side of the screen and the reference station view is on the right side of the screen).
- Tap on a surface that is visible from both stations. Once you select a surface, a white circle will appear. On the other screen, select the same surface. A white dot should appear.
- Tap on a different surface visible from both stations on both screens. These points should be blue. See the example below:



Tip

Choosing flat, bright-colored, non-reflective surfaces produces the best results when using Splitview as these areas have more accurate scan data.

- Once both points have been selected on both screens, tap **Register**.
- Repeat these steps if the scan fails to register again. If the scans still do not register successfully, you may want to scan the area in between these two stations to better stitch together the data.
- In order to have the most accurate scans and registration, it is suggested that you refine the scans once you have finalized the registration process.

9.10 X7 Refining Scans

1. Tap the **Scan** icon.
2. Select the **Refine** button.
3. On the bottom of the screen, a menu will appear. Press the **Refine** button to begin the refining process.
4. Once the refining process is complete, the **Report** tab will no longer be greyed out. You will now be able to view your report by tapping the **Preview** button. This report will tell you how well the scans are refined and registered by giving you the average error in millimeters, the confidence percentage, and the average overlap. You can save the report anywhere on your device or use the default location of Documents/TrimbleFieldLink/Reports.

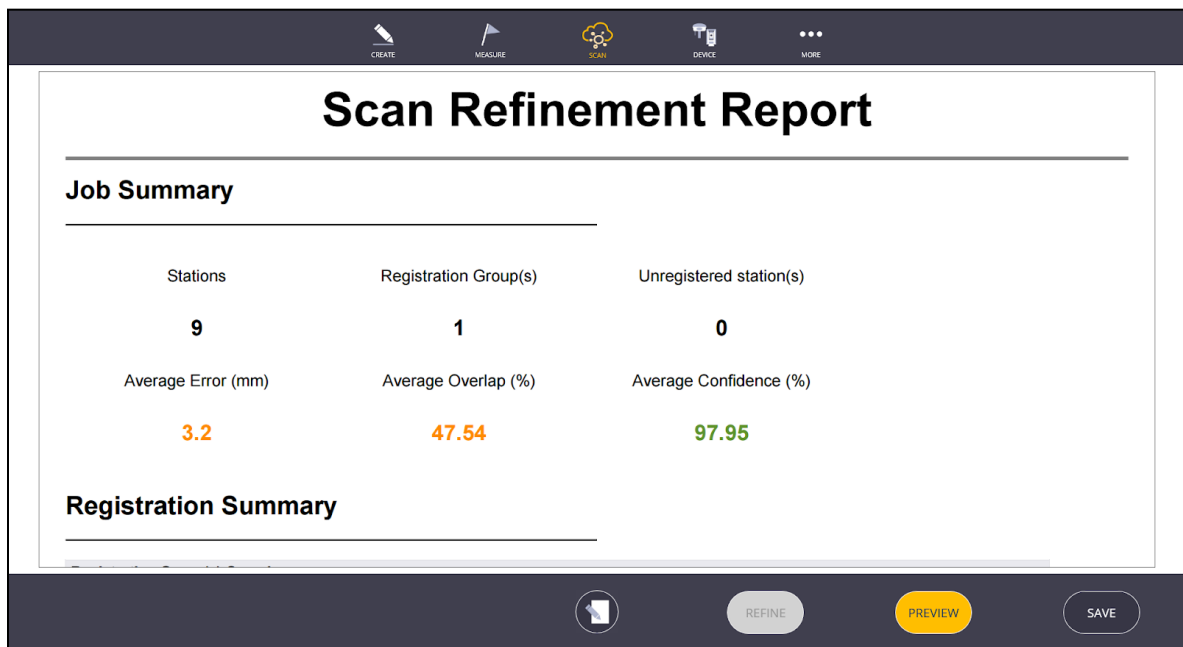

9.11 X7 Scan Export and Diagnostics Report

9.11.1 Export

Once you have finished scanning, you can export your scans to view later in FieldLink Office, Trimble Realworks, SketchUp and other supported CAD software. To export your scans:

1. Select the **Scan** icon
2. Select **Export**
3. On the bottom bar, press the dropdown menu and select which file type you would like to export your project. The options will be TDX, POD, LAS, RCP, TZF, Gridded E57 and Non-Gridded E57.
4. Once you have selected which file type you want to export, click the **Export** button.
5. This will bring up the export menu where you can choose where you would like to export the file to on

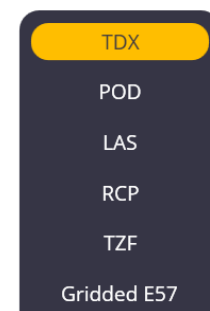

your device and it gives you the option to either refine or colorize the points while you export (use the up arrow to navigate between save folders). If you have already colorized and refined, the checkboxes will be checked and greyed out.

6. Click the **Export** button again to begin the export process. Export time will depend on how many scans you have, whether your points have been colorized or not and whether the file has been refined yet.

9.11. 2 Diagnostics Report

If you encounter an issue with your X7 or would like to check the status of your instrument's health, you can do so with the built-in diagnostics report function. To create a diagnostics report:

1. Ensure you are connected to your Trimble X7 laser scanner
2. Tap on **Device > Settings > Diagnostic**
3. Once you tap on the Diagnostic button, your Trimble X7 will begin spinning and the yellow lights will flash. Make sure to not touch or move your X7 while it is moving.

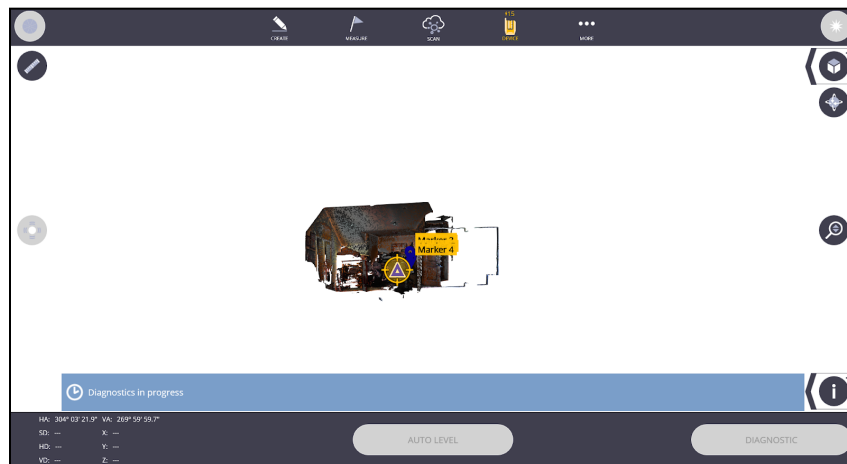

4. The diagnostics report will automatically appear once it has finished and the lights on the Trimble X7 turn green. Here you will have the option to change the file save location and file name using the **Edit** button.

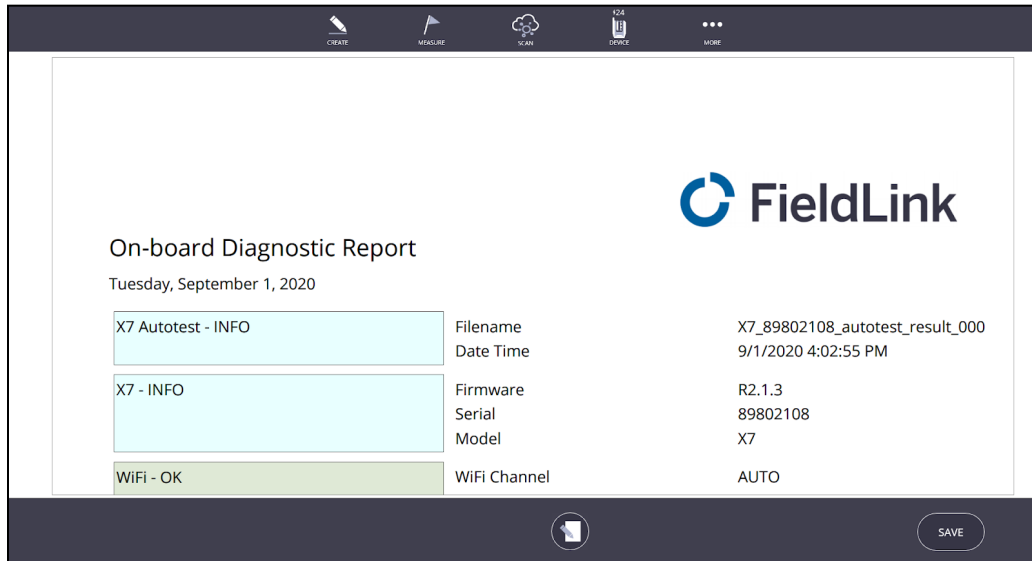

5. Once you have viewed the report and have chosen a save location, tap on the **Save** button. The default save location is **User > Documents > FieldLink > Reports > Diagnostic Reports**

9.11.3 Calibration Report

1. To access the X7 instruments Calibration Report:
2. Ensure you are connected to the Trimble X7
3. Tap on **Device**
4. Tap on **Settings**
5. Then select **CALIBRATE INSTRUMENT**

Overall Result	Success	
X7 Fieldcalibration Report INFO	Date Time	10/5/2020 2:32:55 PM
X7 INFO	Firmware	R2.1.4
	Serial	89802108
	Model	X7
Condition PASS	Runtime	16 min
	Temperature	23 °C
	Inclination	1.6 °
	Vibration	Low
	Ambient light	PASS

You will have the option to save this report. If you save the report, it can be found under **Users > USERNAME > Documents > FieldLink > Reports**

9.11.4 Log Files

If FieldLink encounters an error or crash, Trimble Support may ask for the log files in order to better understand what caused the issue. To access these log files:

Through FieldLink

1. Tap on **More > About**

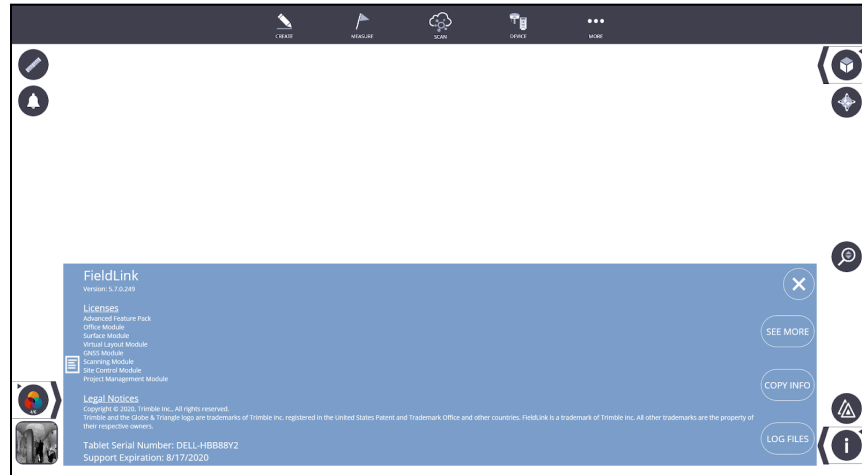

2. The About menu will appear. Tap on **Log Files** in the bottom right hand corner.
3. This will cause your native file explorer to open revealing the save location of the FieldLink Log Files.
4. Select the Sessions folder and find the most recently saved file from your project.

Name	Date modified	Type	Size
FieldLink 2020-05-14T12_11_10.log	5/14/2020 4:16 PM	Text Document	1,511 KB
FieldLink 2020-05-29T12_05_00.log	5/31/2020 2:06 PM	Text Document	17 KB
FieldLink 2020-06-12T10_09_43.log	6/12/2020 8:17 PM	Text Document	8 KB
FieldLink 2020-06-16T16_11_07.log	6/16/2020 6:22 PM	Text Document	5 KB
FieldLink 2020-06-18T10_13_35.log	6/19/2020 10:02 PM	Text Document	8 KB
FieldLink 2020-06-22T15_13_00.log	6/22/2020 4:59 PM	Text Document	84 KB
FieldLink 2020-06-22T17_29_57.log	6/23/2020 12:54 AM	Text Document	640 KB
FieldLink 2020-06-24T15_48_44.log	6/25/2020 1:40 PM	Text Document	18 KB
FieldLink 2020-06-25T13_38_32.log	6/25/2020 1:38 PM	Text Document	1 KB

Through File Explorer

1. Open your file explorer
2. Make sure that "Hidden Items" is checked under the view ribbon. You will need to check this in order to see the AppData folder.

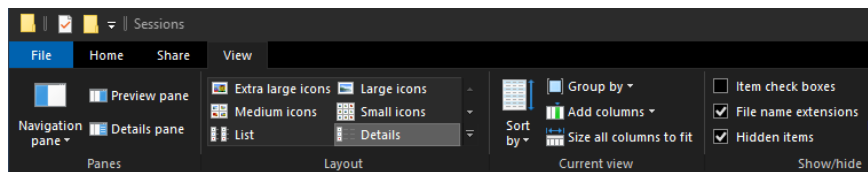

3. The save location for Log Files is Users > Username > AppData > Local > FieldLink > LogFiles > Sessions

10. GNSS Module

FieldLink offers the ability to connect to the SPS986 and or the R8s to layout and collect points within FieldLink.

Both of our receivers are NTRIP capable and here are some additional supported data inputs and outputs;

- Trimble SPS986
 - Correction data (input): CMR™, CMR+™, CMRx™, RTCM 2.x, RTCM 3 (require Rover upgrade)

- Correction data (output): CMR, CMR+, CMRx, RTCM 2.x, RTCM 3 (require Base upgrade)
- Trimble R8s
 - R8s Data Formats (inputs and outputs) • CMR, CMR+, CMRx, RTCM 2.1, RTCM 2.3, RTCM 3.0, RTCM 3.1, RTCM 3.2

10.1 GNSS Set Up

1. Unknown Location Set Up - See 5.7.8 GNSS Set Up - Unknown Location (3 points)
2. Known Location Set Up - See 5.7.9 GNSS Set Up - Known Point
3. No Data Set Up - Set Up - See 5.7.10 GNSS No Data Set Up

10.2 Tilt Calibration

Once you have set up the Base Station and Rover, it is possible to enable the tilt compensation feature. Complete the plumb pole routine to calibrate the Rover pole. After calibration, it is possible to layout or collect without leveling the Rover pole.



Note

- The use of the quick release is not recommended when using Tilt Compensation
- Tilt will not work with a pole less than 1.5 meters in height, either physically or a user populated height.

1. Go to the Prism button
2. Check the Enable Tilt Compensator box
3. Click the Plumb Pole button

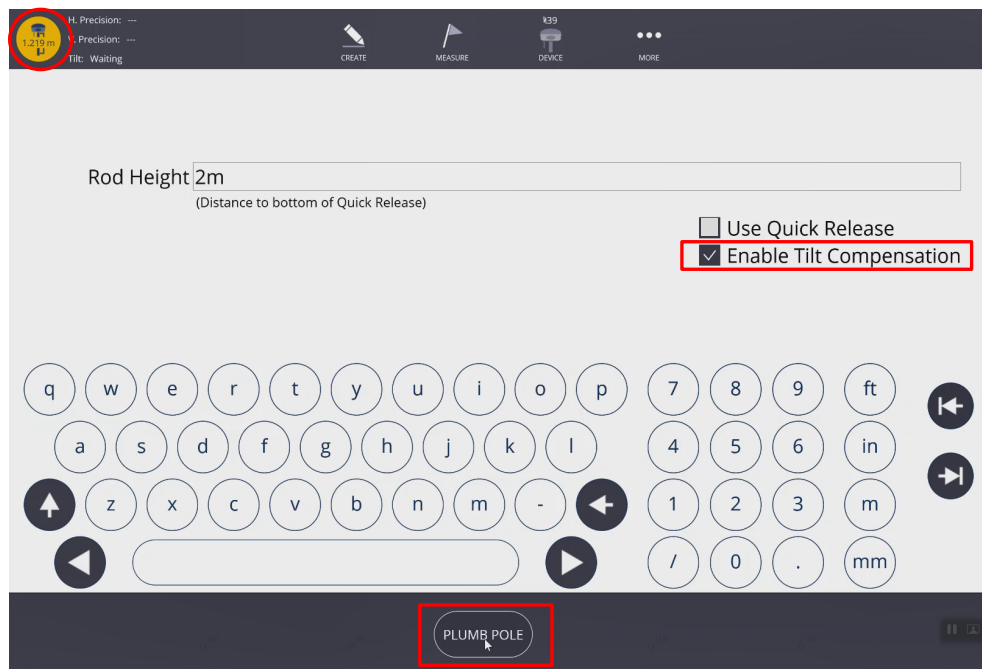

4. Set the tip at fixed location
5. Rotate the pole to the designated pie piece and keep it in the green during the first part of the calibration procedure
6. Click Start



Important

Do not move the tip of the pole.

7. Once the first part is complete the toast will tell you to rotate the pole 180 degrees (do not move the tip) and hit Continue
8. Repeat the same step as before
9. The apply corrections toast appears and hit Yes
10. Plumb Pole corrections successfully applied toast appears and you're done



Note

If you switch poles this step will need to be repeated

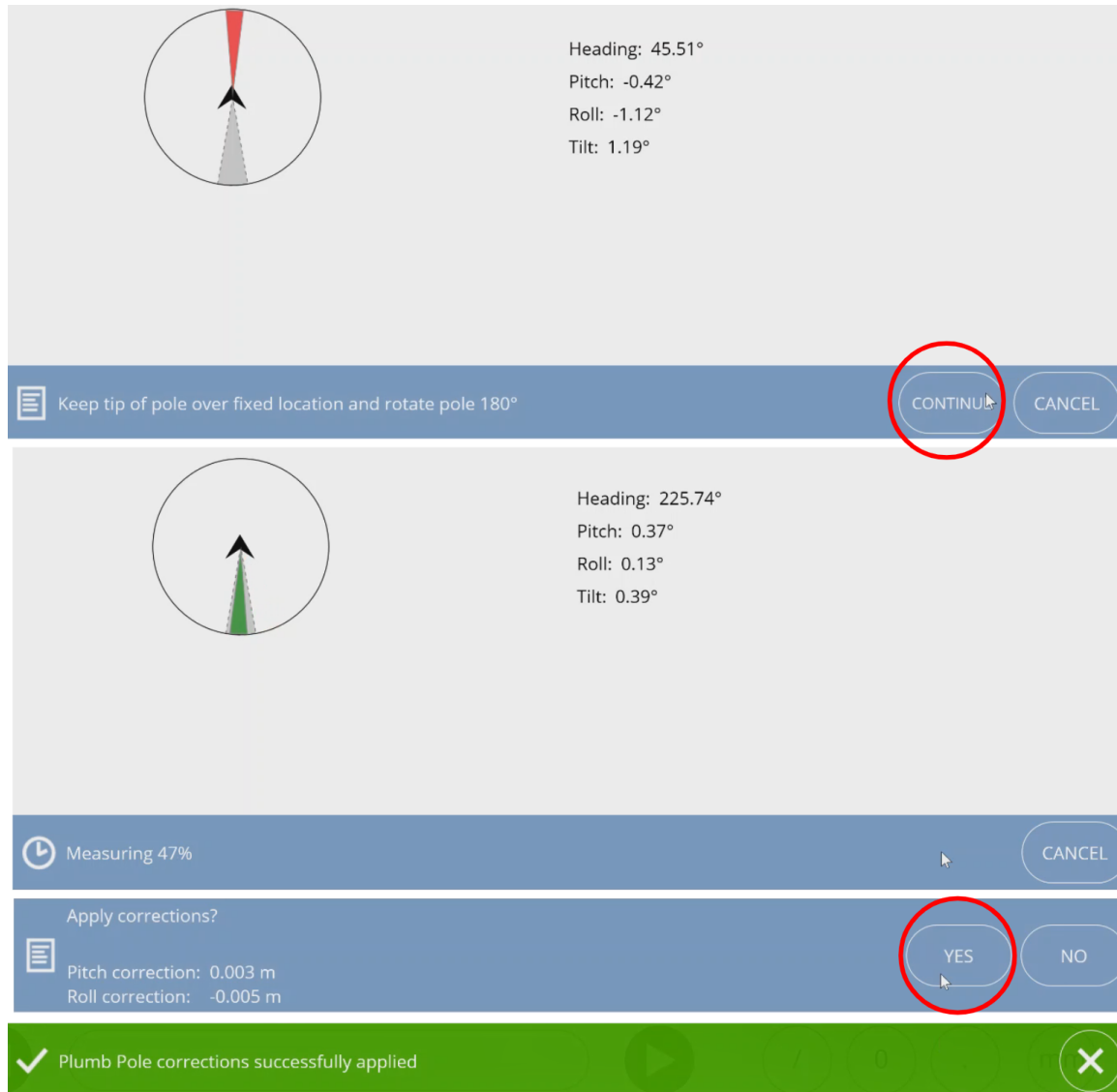

10.3 Layout

Once we have connected to the Base Station and Rover and set up on the project, you can now collect and lay out points, lines and arcs.

1. Select Measure
2. Select Layout
3. Select a point to layout
4. The Grey arrow show the direction you need to go

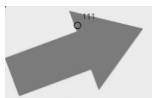

5. The smaller blue bullseye with arrow (available with tilt compensation) shows what direction you are pointed

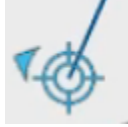

Note

With the Tilt Compensator you have both indicators. If you don't have the tilt compensator enabled you will only see the grey arrow.

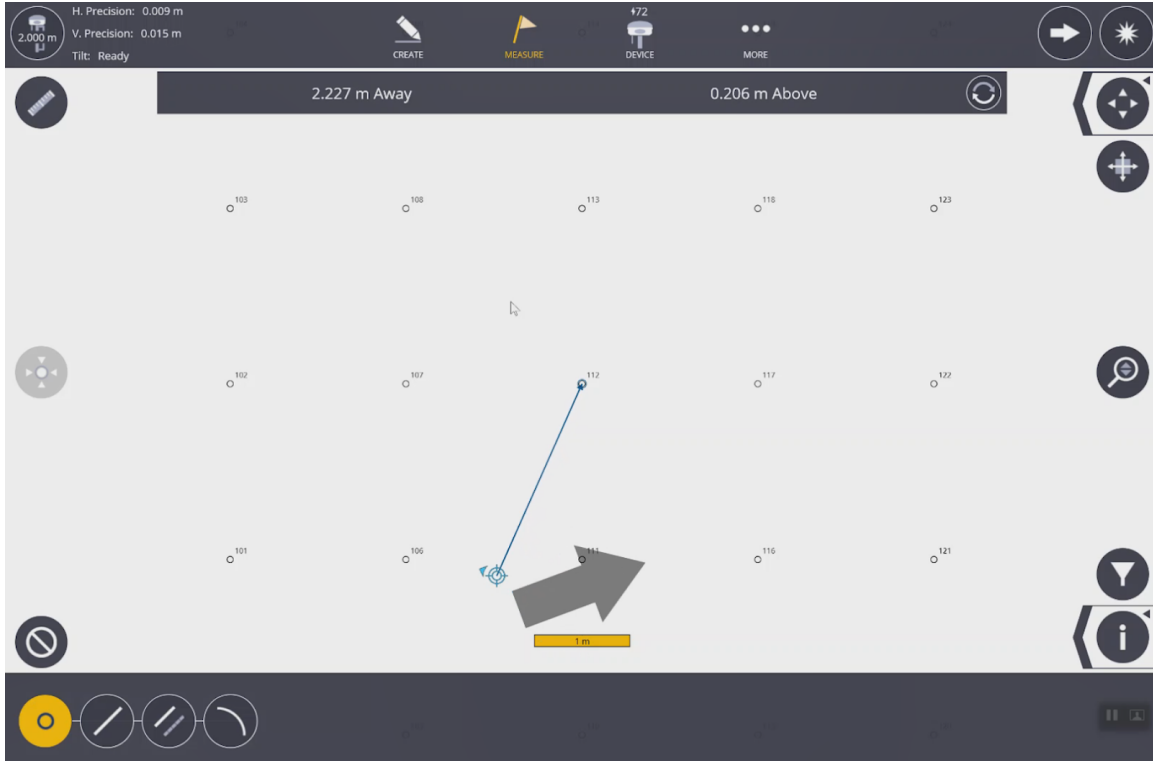

11. Robotics Module - Spot Integration

For Robotics please reference the Robotics (version specific) User guide.